

DENAH RENCANA
SKALA 1:100

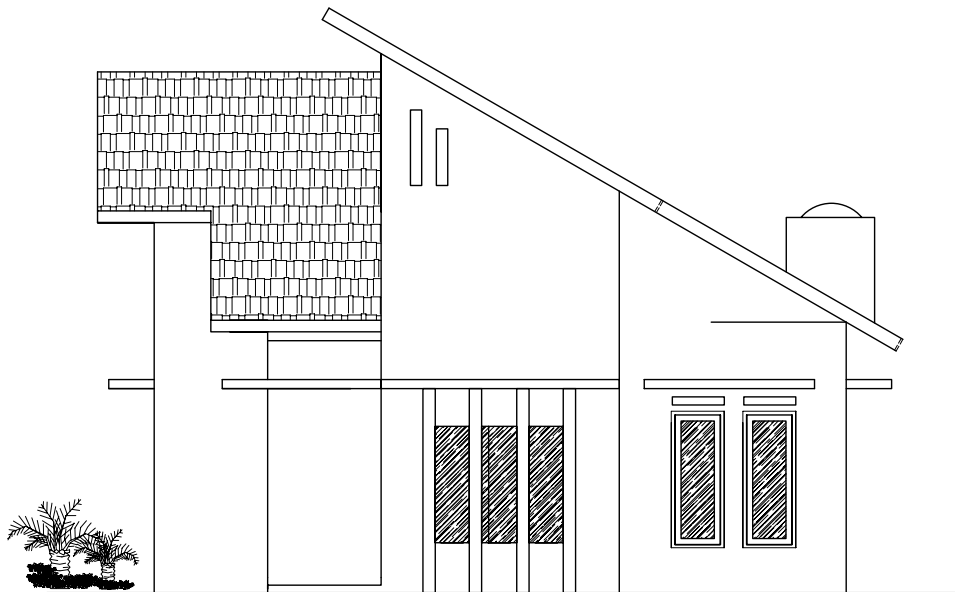

TAMPAK DEPAN
SKALA 1:100



ARGAJOGJA

Architecture, Interior, Furniture, Engineering

Official Website: www.argajogja.com Website: www.blogargajogja.com

Email : argajogjaconr@gmail.com

Phone/WA : 081328784647

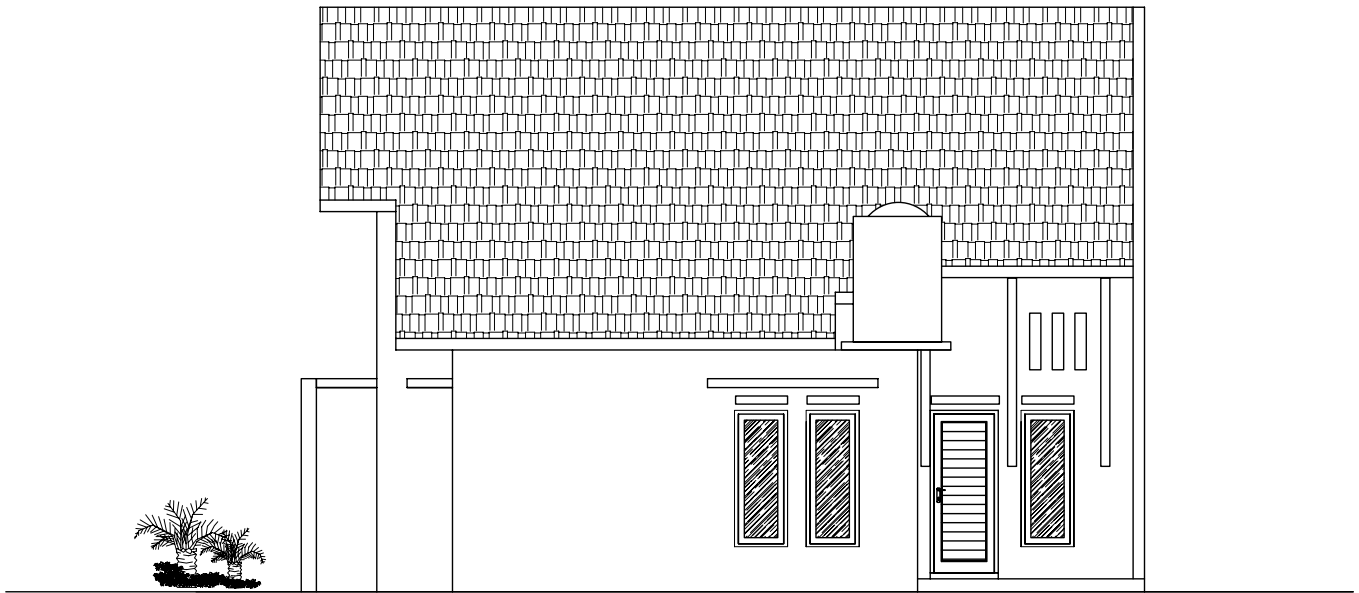

TAMPAK KANAN
SKALA 1:100



ARGAJOGJA

Architecture, Interior, Furniture, Engineering

Official Website: www.argajogja.com Website: www.blogargajogja.com

Email : argajogjaconr@gmail.com

Phone/WA : 081328784647

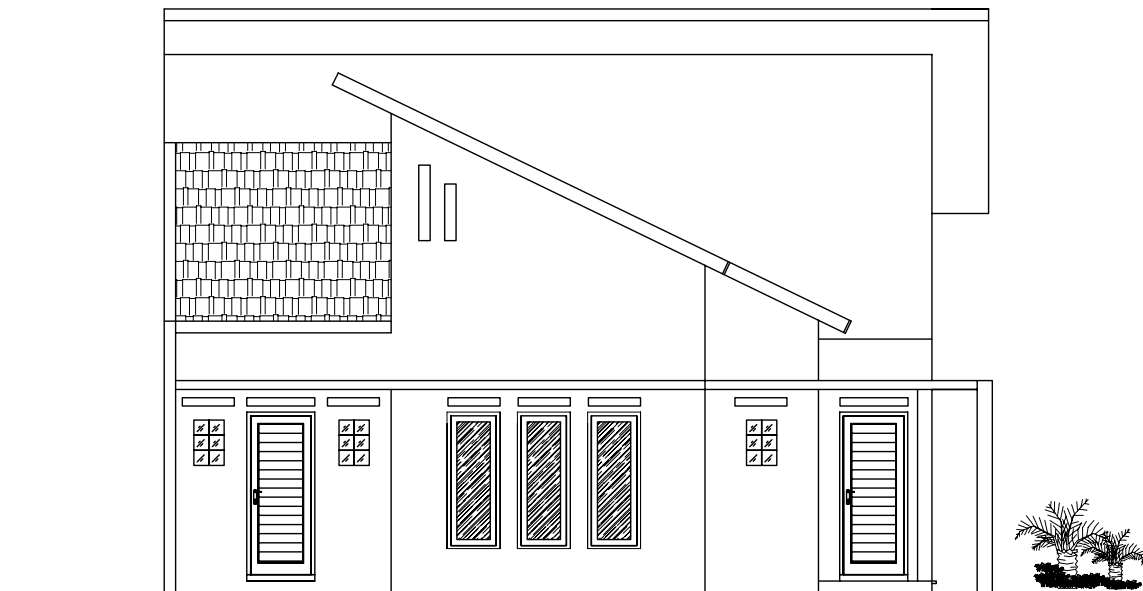

TAMPAK KIRI
SKALA 1:100



ARGAJOGJA

Architecture, Interior, Furniture, Engineering

Official Website: www.argajogja.com Website: www.blogargajogja.com

Email : argajogjaconr@gmail.com

Phone/WA : 081328784647

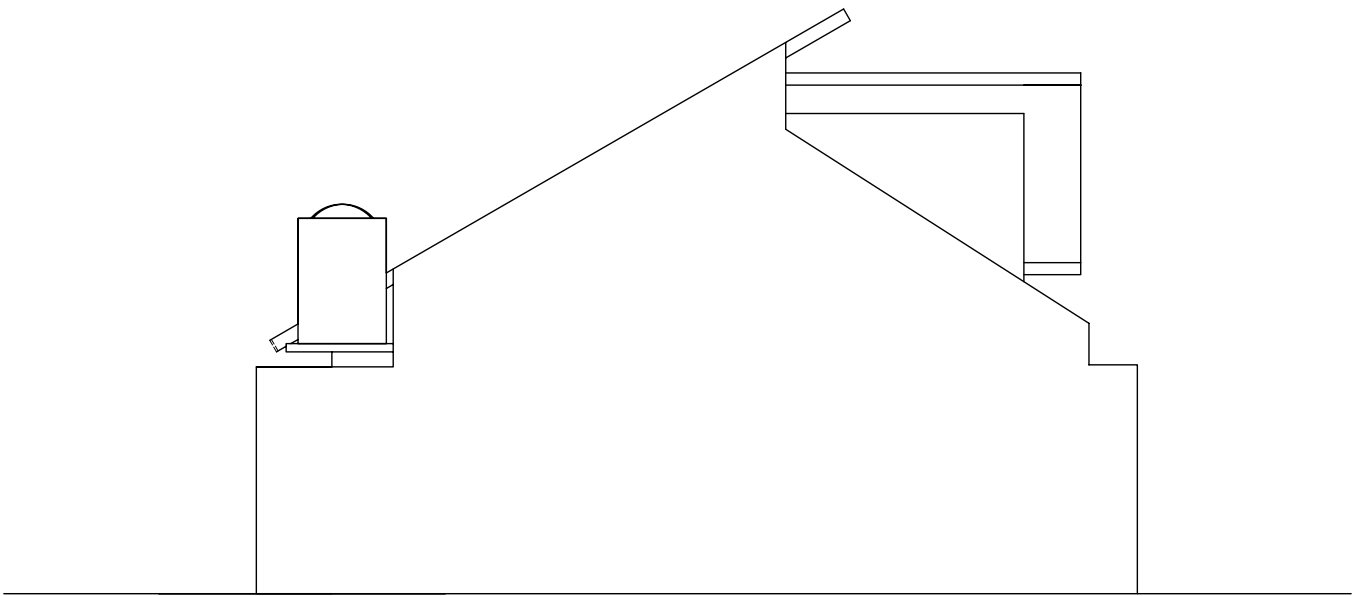

TAMPAK BELAKANG
SKALA 1:100



ARGAJOGJA

Architecture, Interior, Furniture, Engineering

Official Website: www.argajogja.com Website: www.blogargajogja.com

Email : argajogjaconr@gmail.com

Phone/WA : 081328784647

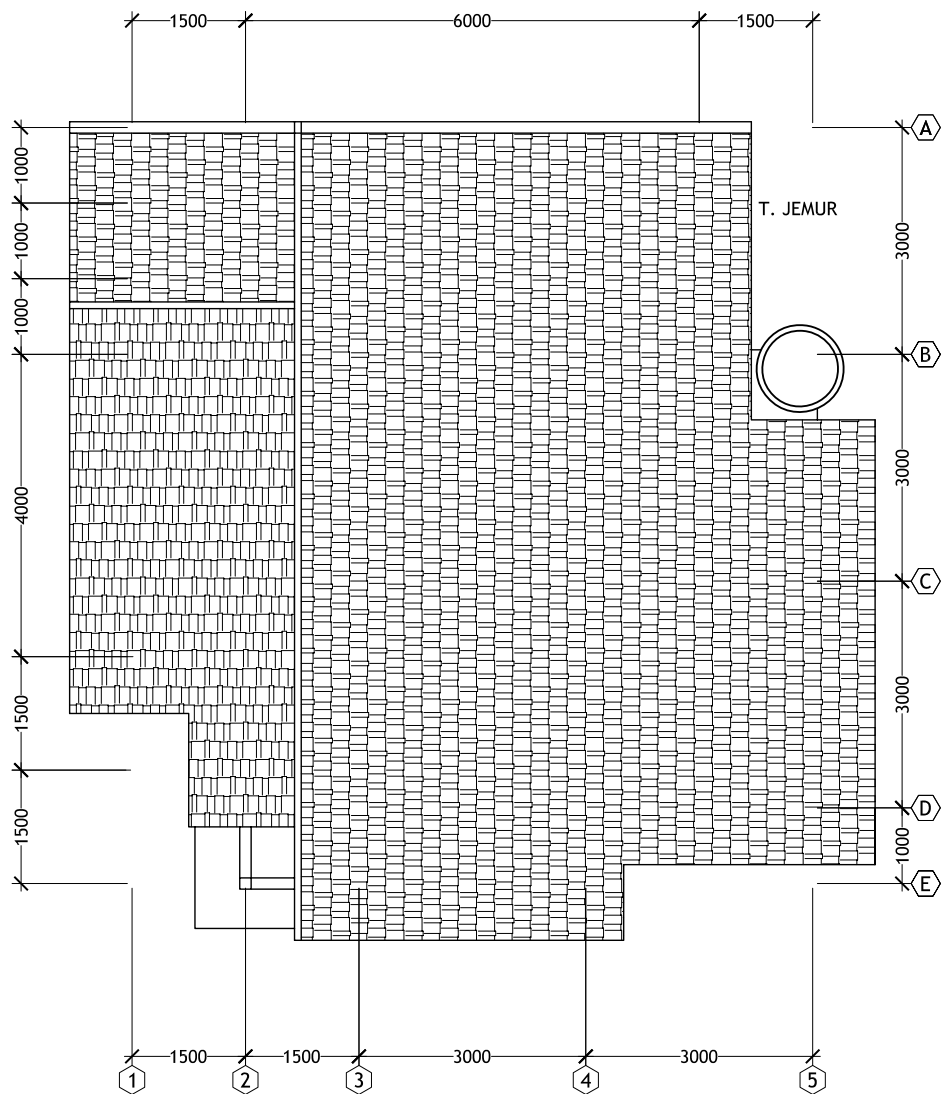

RENCANA ATAP
SKALA 1:100

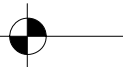

ARGAJOGJA

Architecture, Interior, Furniture, Engineering

Official Website: www.argajogja.com Website: www.blogargajogja.com

Email : argajogjaconr@gmail.com

Phone/WA : 081328784647

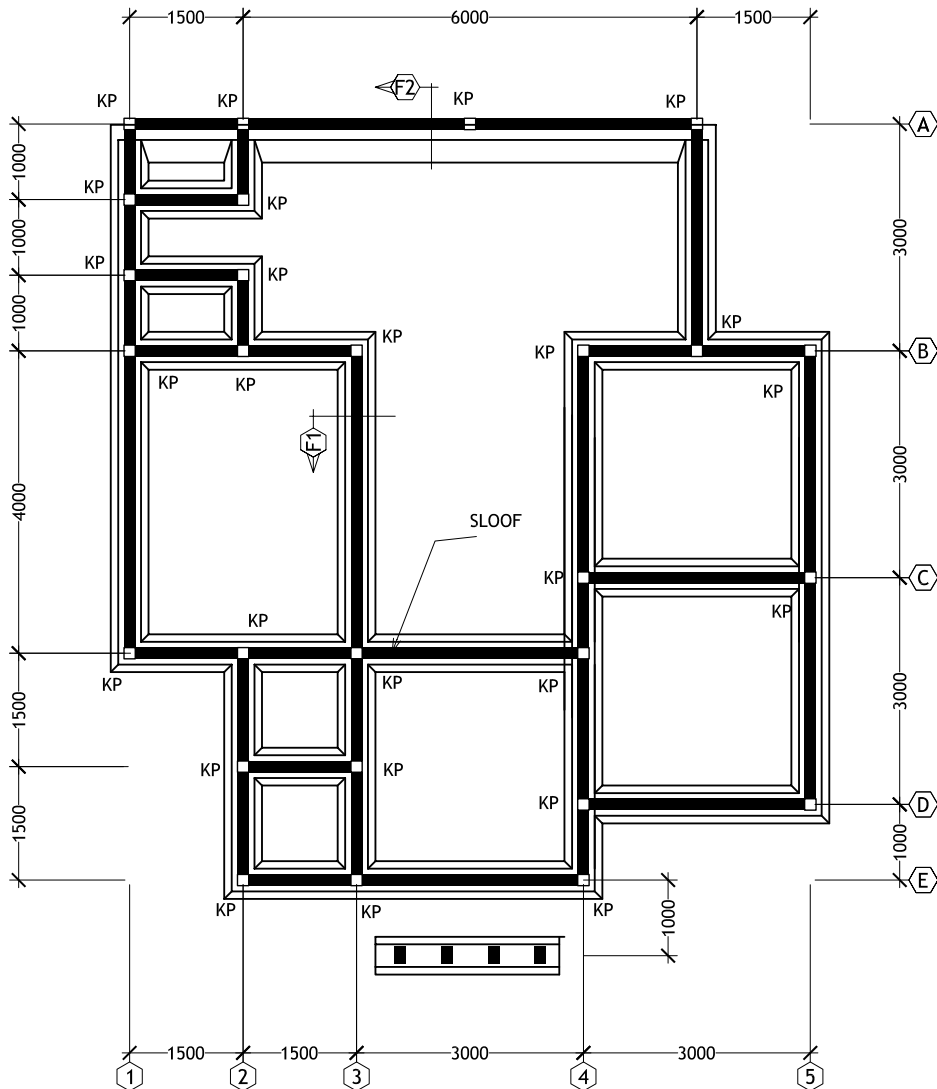

RENCANA PONDASI, KOLOM PRAKTIS DAN SLOOF
SKALA 1:100



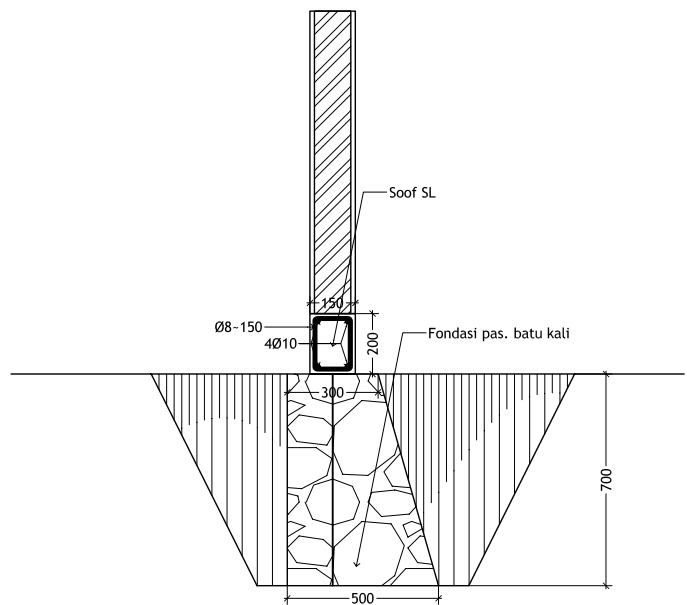
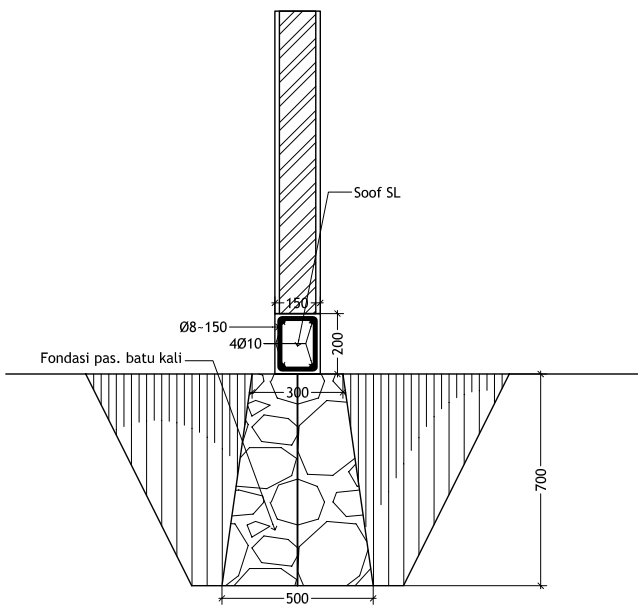
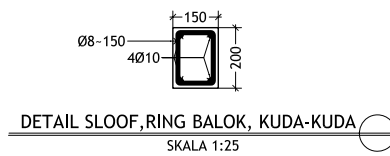
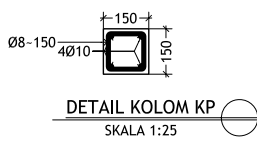

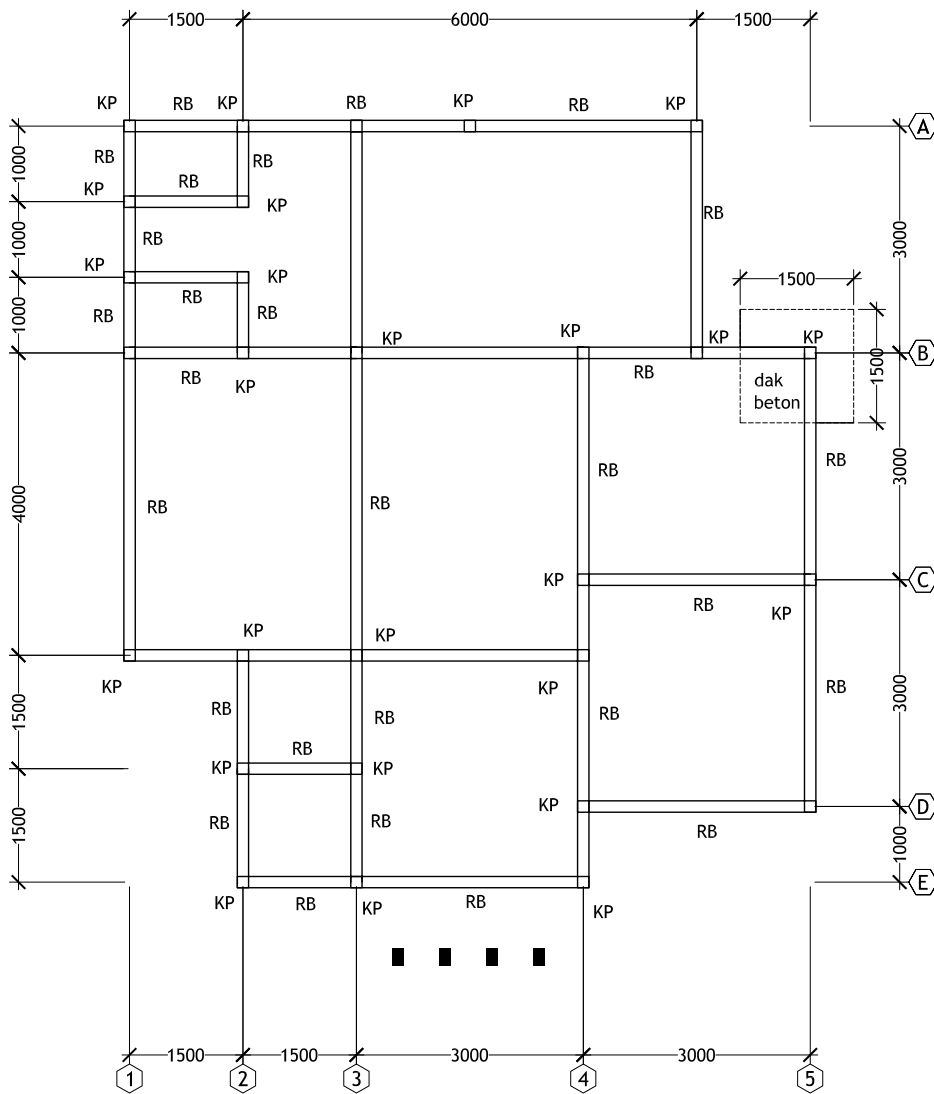

RING BALOK
SKALA 1:100

- KP = Kolom Praktis
- RB = Ring Balok



ARGAJOGJA

Architecture, Interior, Furniture, Engineering

Official Website: www.argajogja.com Website: www.blogargajogja.com

Email : argajogjaconr@gmail.com

Phone/WA : 081328784647

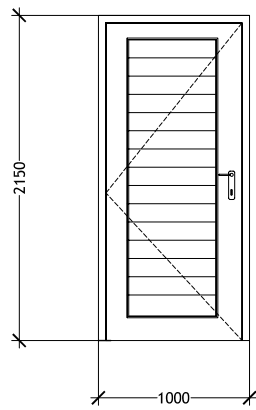

DETAIL P1

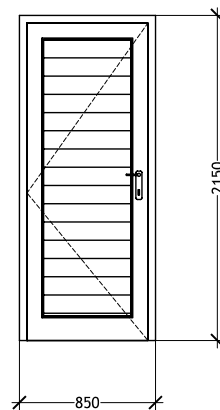

DETAIL P2

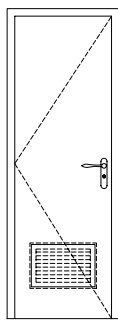

DETAIL P3
UKURAN STANDAR PABRIK

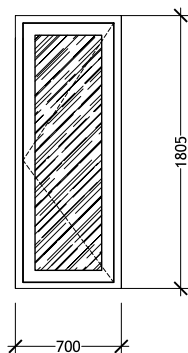

DETAIL J1

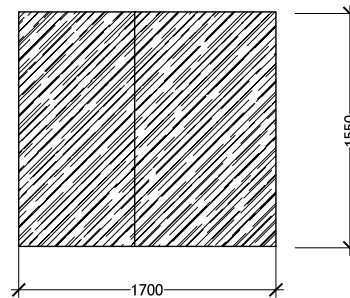

DETAIL J2
KACA TEBAL
TIDAK PAKE KUSEN

DETAIL PINTU JENDELA

SKALA 1:50



ARGAJOGJA

Architecture, Interior, Furniture, Engineering

Official Website: www.argajogja.com Website: www.blogargajogja.com

Email : argajogjaconr@gmail.com

Phone/WA : 081328784647

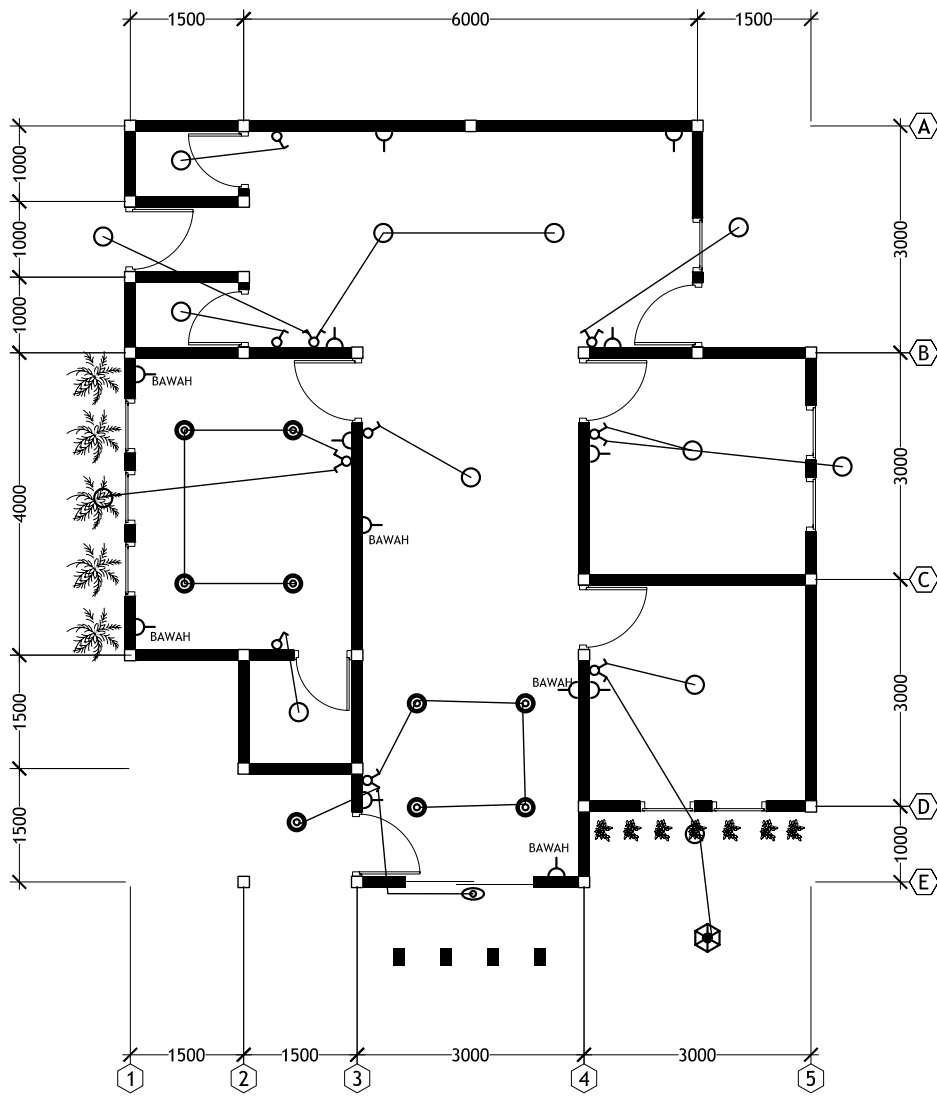

DENAH ELEKTRIKAL
SKALA 1:100

SIMBOL	KETERANGAN	SIMBOL	KETERANGAN
	= Lampu dinding luar ruangan SL 23 watt		= SAKLAR ganda/ SERI
	= Lampu taman SL 18watt		= SAKLAR TUNGGAL
	= Down light with 18 sl		= OUTLET STOP KONTAK 250VA
	= SL Philips 23 watt		

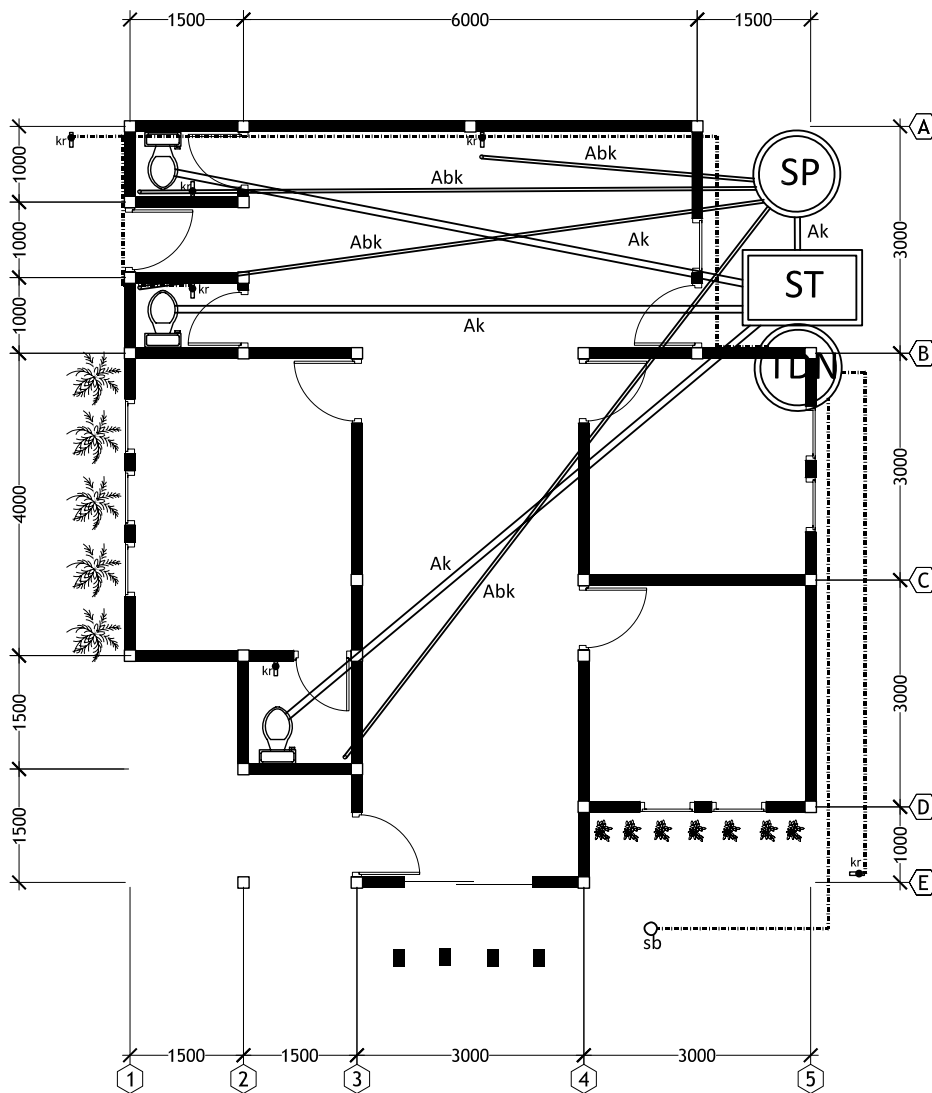

DENAH SANITASI
SKALA 1:100



SIMBOL	KETERANGAN
	= SUMUR RESAPAN
	= SEPTIC TANK
	= TANDON
	= SUMUR AIR BERSIH
Ak	= Pipa Air kotor



ARGAJOGJA

Architecture, Interior, Furniture, Engineering

Official Website: www.argajogja.com Website: www.blogargajogja.com

Email : argajogjaconr@gmail.com

Phone/WA : 081328784647