

GAMBAR KERJA RUMAH 2 LANTAI

Milik :
Pak Surtipta

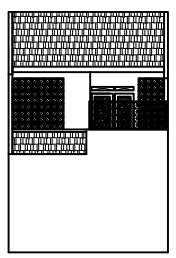
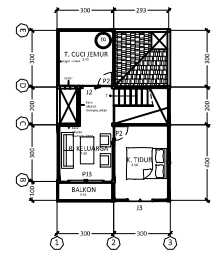
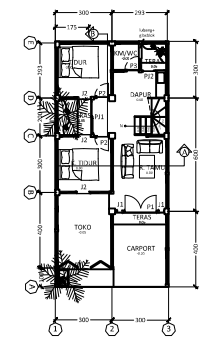

NOTASI	R-1	R-2	R-3	Rd
GAMBAR				
UJUK/NO	200 x 200	200 x 200	200 x 200	1500 x 150
PLACEMENT	APRIL 10000	APRIL 10000	APRIL 10000	APRIL 10000

NOTASI	SL	B1	B2	B3	RB
GAMBAR					
UJUK/NO	200 x 200	200 x 200	200 x 200	200 x 200	150 x 200
PLACEMENT	APRIL 10000	APRIL 10000	APRIL 10000	APRIL 10000	APRIL 10000

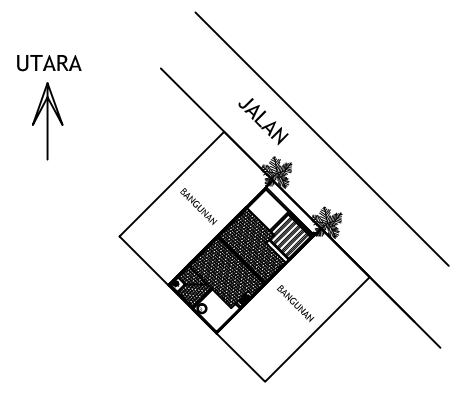
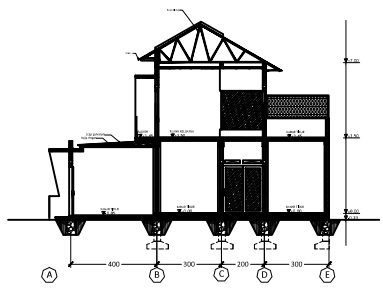
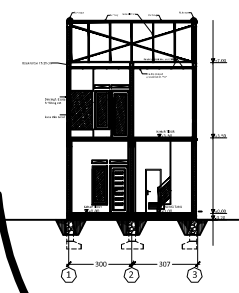

design by

ARGAJOGJA
 Architecture, Interior, Engineering

UTARA

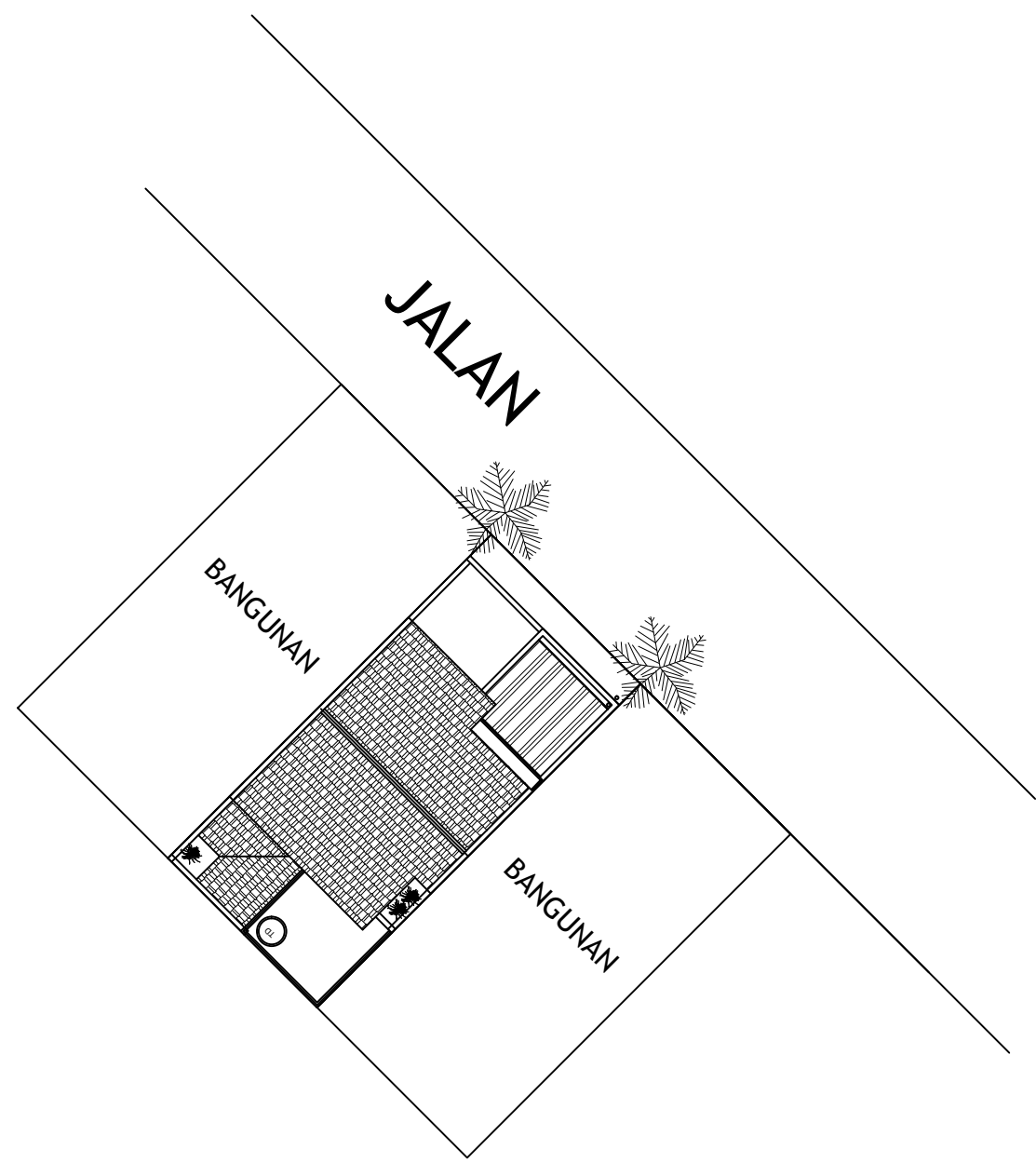
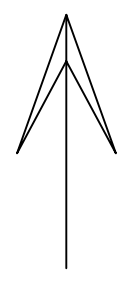

PROJECT NAME	ARCHITECT	OWNER	TITLE	SCALE	NOTE	PAPER
RUMAH 2 LANTAI	 www.argajogja.co.nr	Mr. Supta	DENAH SITUASI	1:200		A3

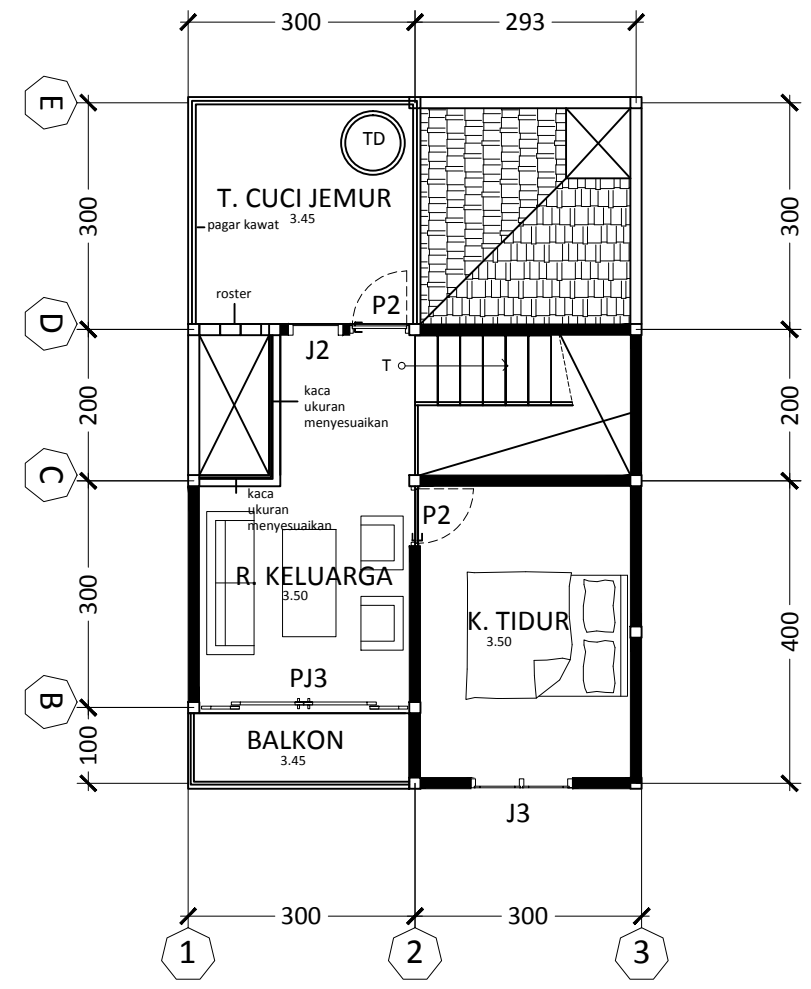
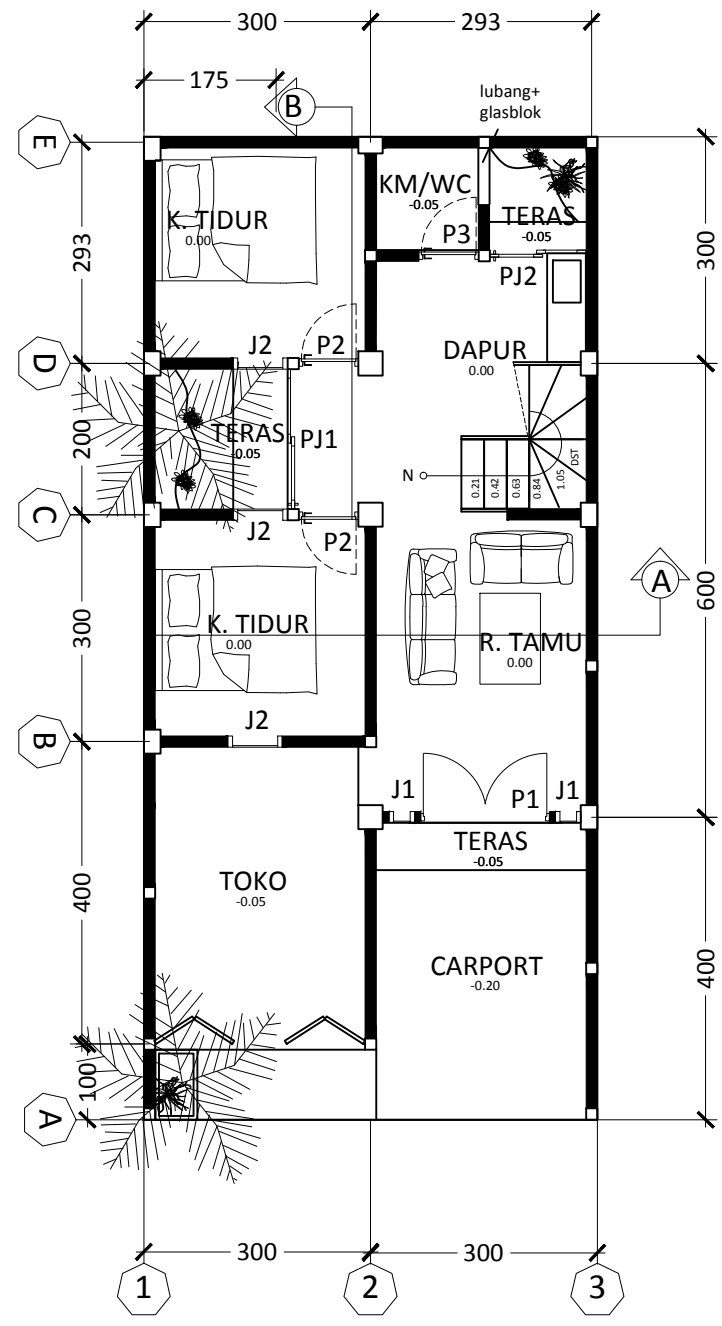

PROJECT NAME	ARCHITECT	OWNER	TITLE	SCALE	NOTE	PAPER
RUMAH 2 LANTAI	 www.argajogja.co.nr	Mr. Supta	DENAH LT 1 & 2	1:100		A3

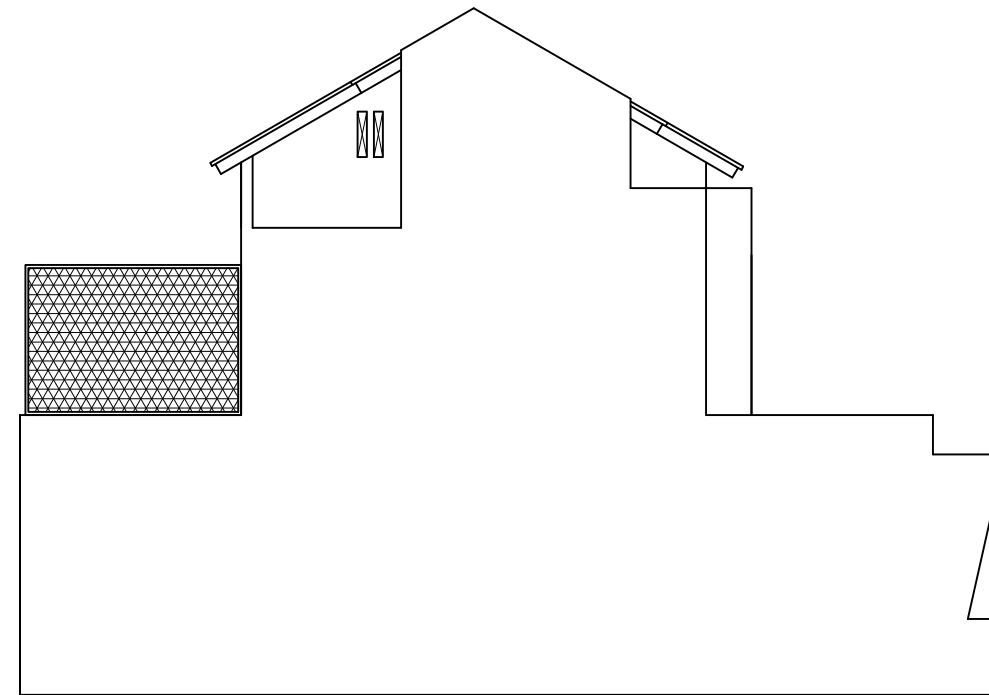
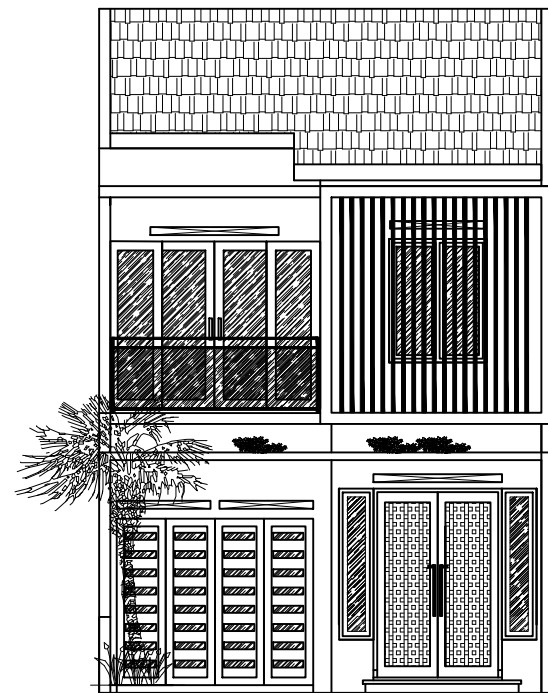

PROJECT NAME	ARCHITECT	OWNER	TITLE	SCALE	NOTE	PAPER
RUMAH 2 LANTAI	 www.argajogja.co.nr	Mr. Supta	TAMPAK DEPAN DAN T. SAMPING KANAN	1:100		A3

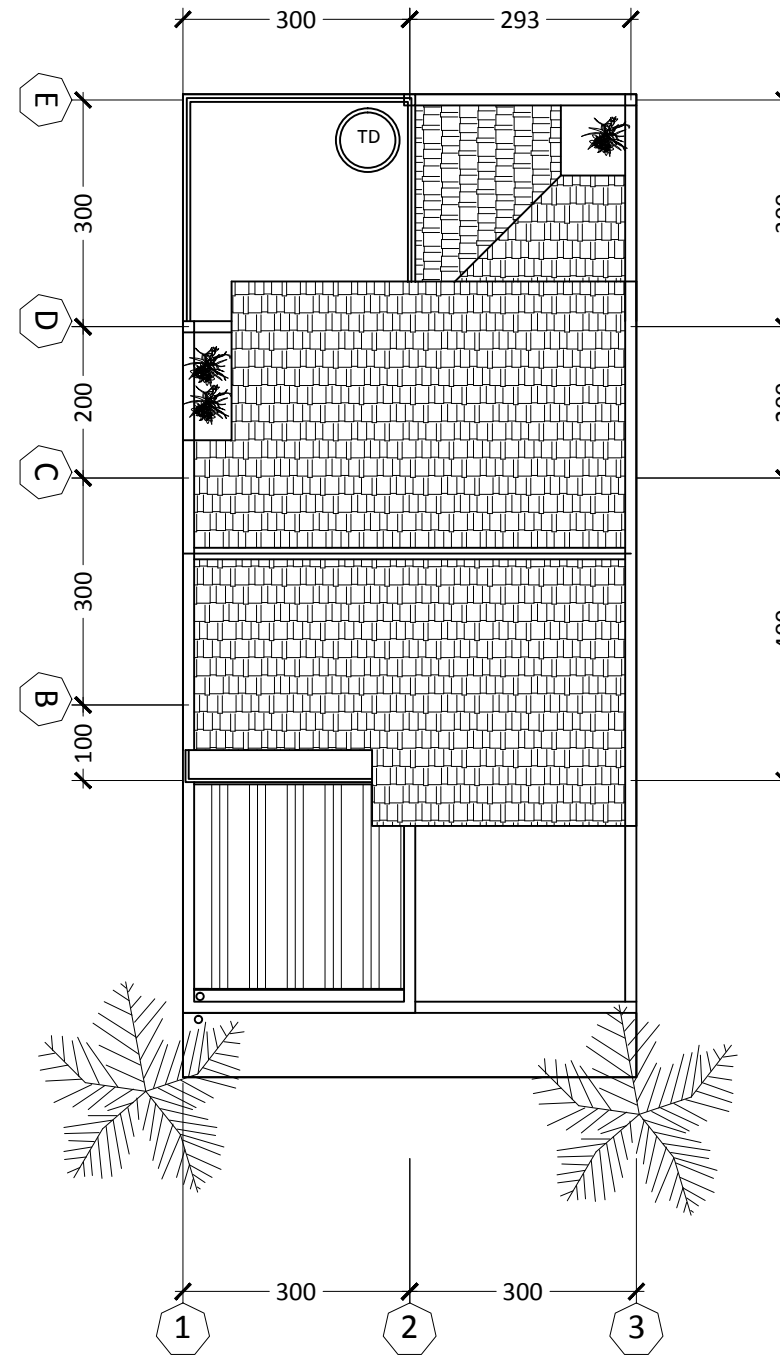

PROJECT NAME	ARCHITECT	OWNER	TITLE	SCALE	NOTE	PAPER
RUMAH 2 LANTAI	 www.argajogja.co.nr	Mr. Supta	RENCANA ATAP	1:100		A3

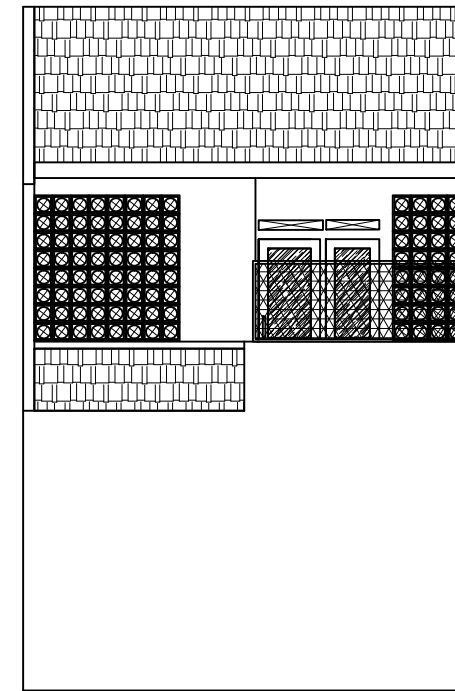
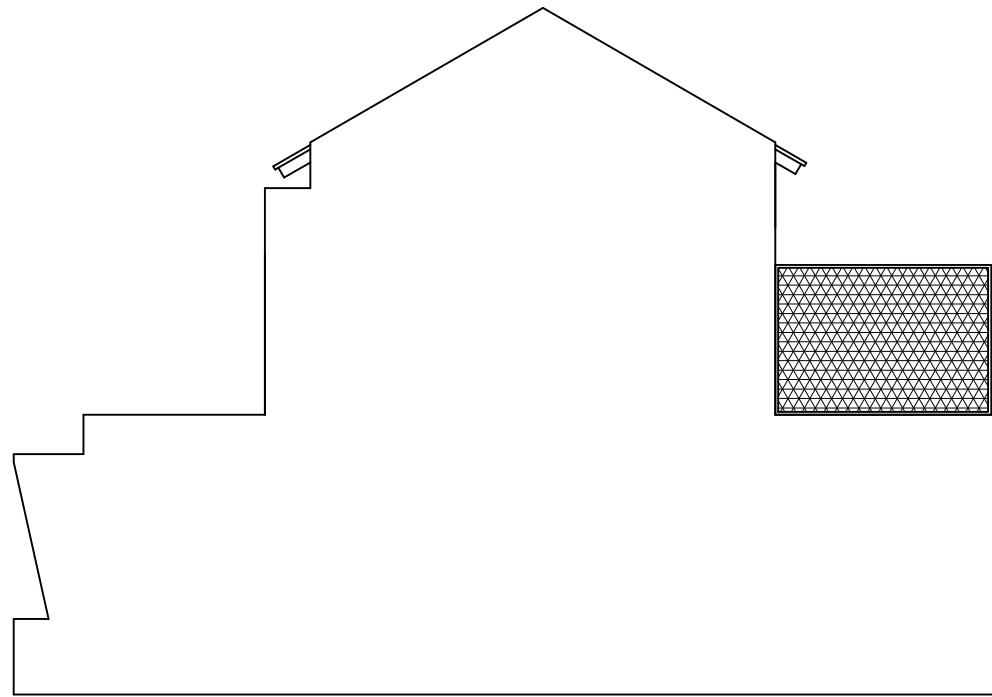

PROJECT NAME	ARCHITECT	OWNER	TITLE	SCALE	NOTE	PAPER
RUMAH 2 LANTAI	 www.argajogja.co.nr	Mr. Supta	T. SAMPING KIRI DAN T. BELAKANG	1:100		A3

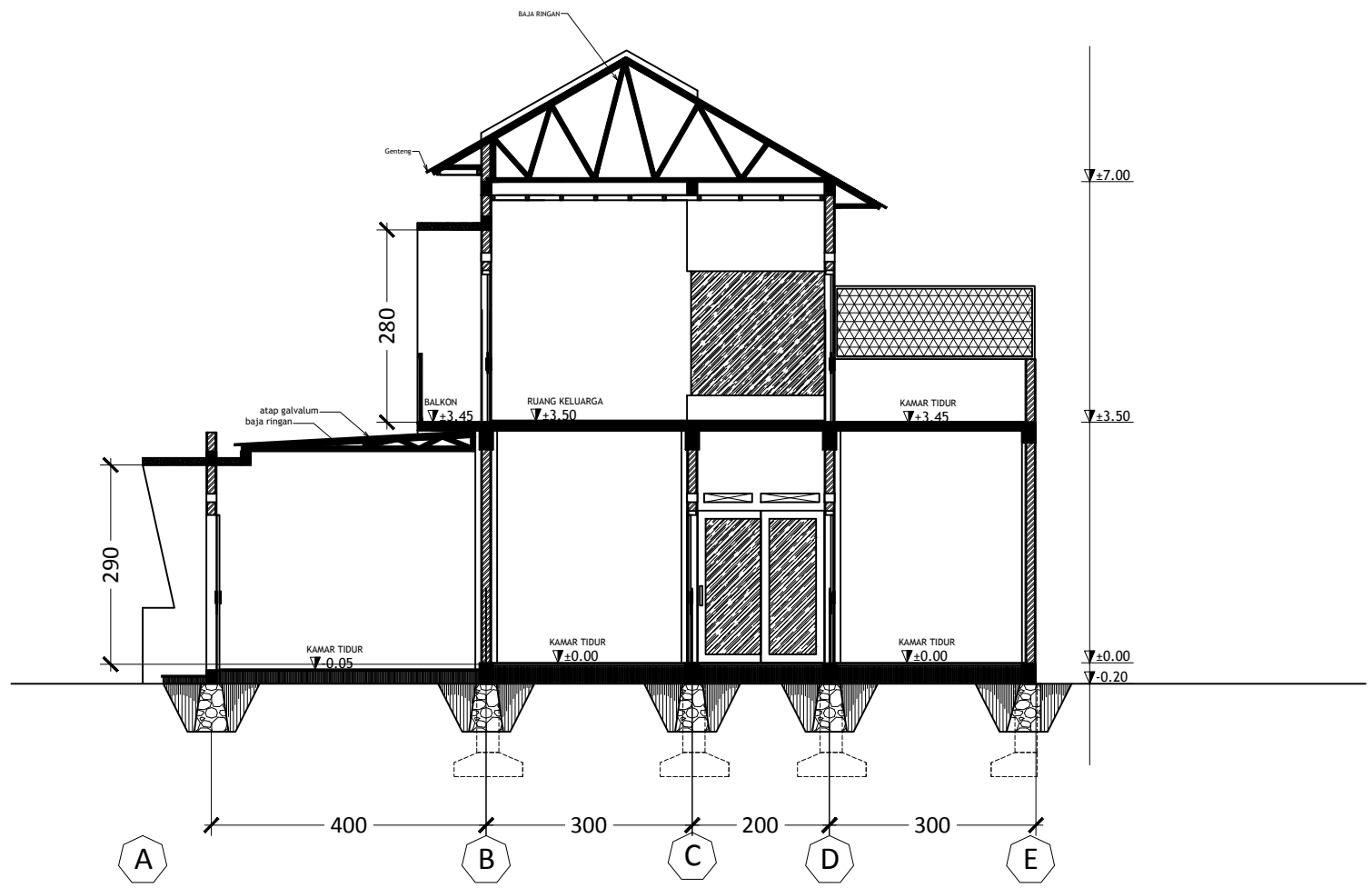
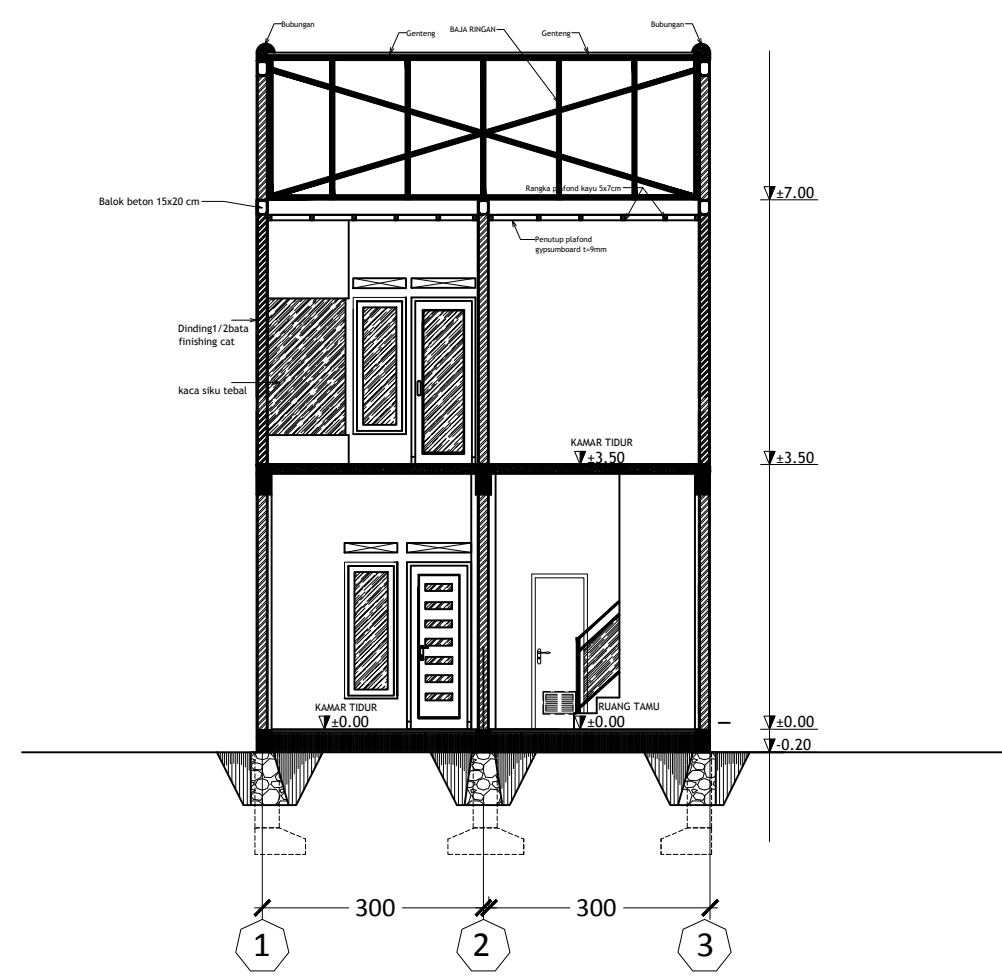

PROJECT NAME	ARCHITECT	OWNER	TITLE	SCALE	NOTE	PAPER
RUMAH 2 LANTAI	 www.argajogja.co.nr	Mr. Supta	POTONGAN A dan POTONGAN B	1:100		A3

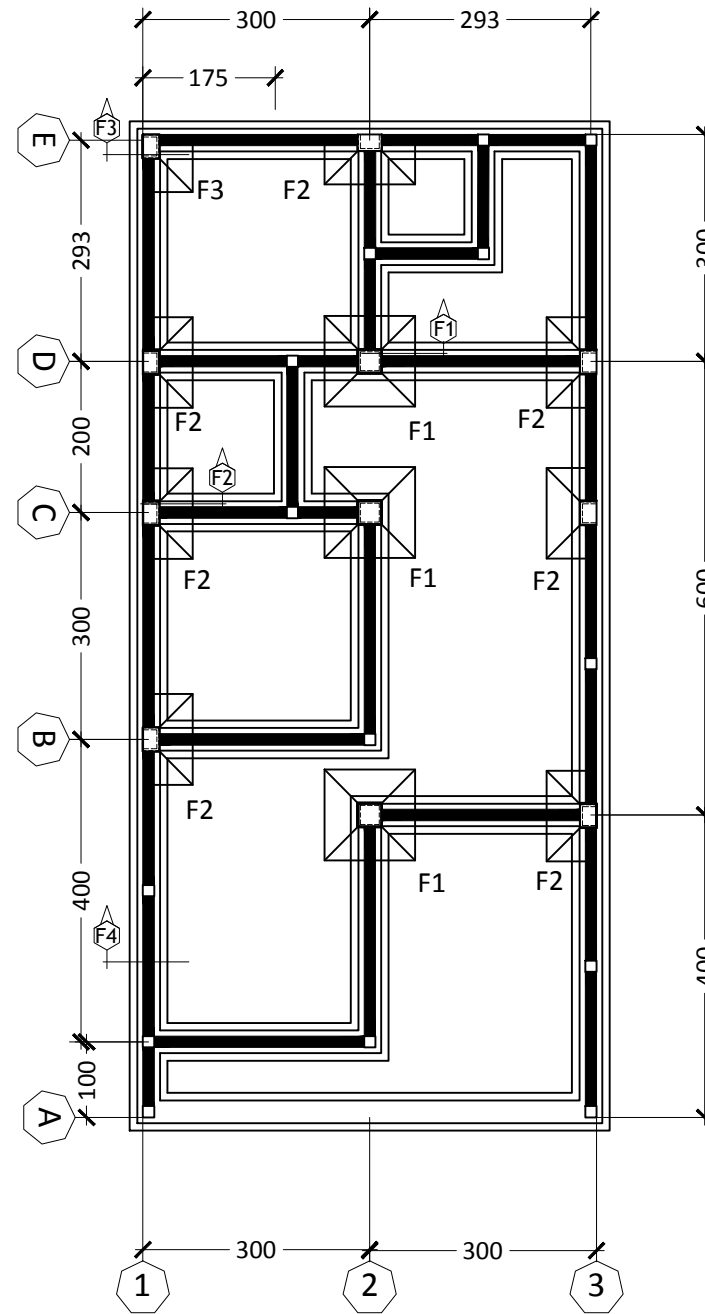

PROJECT NAME	ARCHITECT	OWNER	TITLE	SCALE	NOTE	PAPER
RUMAH 2 LANTAI	 www.argajogja.co.nr	Mr. Supta	RENCANA PONDASI	1:100		A3

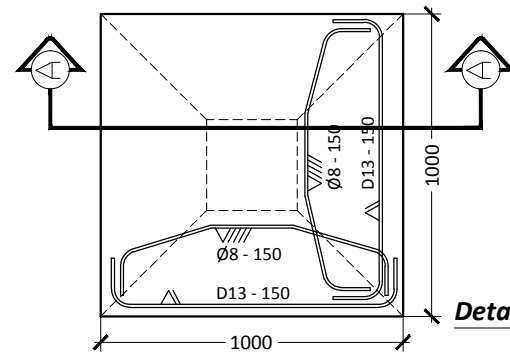

Detail Pondasi F-1

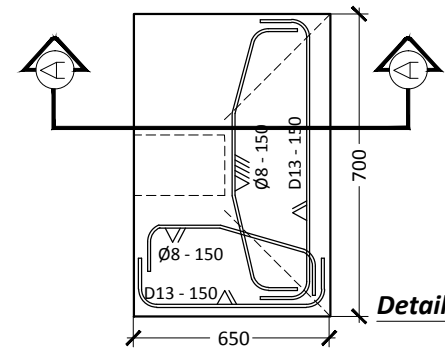

Detail Pondasi F-2

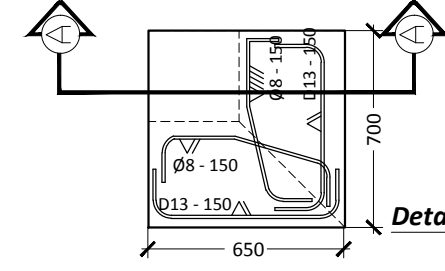

Detail Pondasi F-3

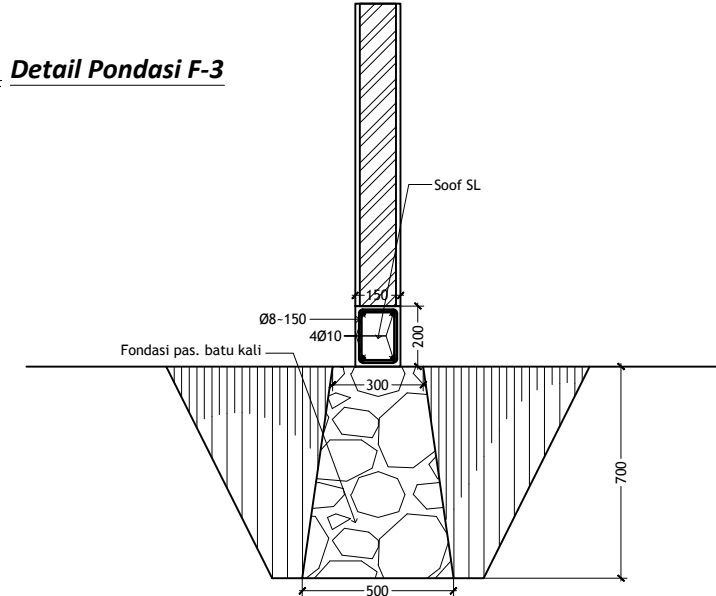
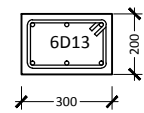
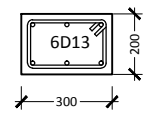
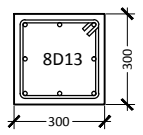

DETAIL FONDASI F4

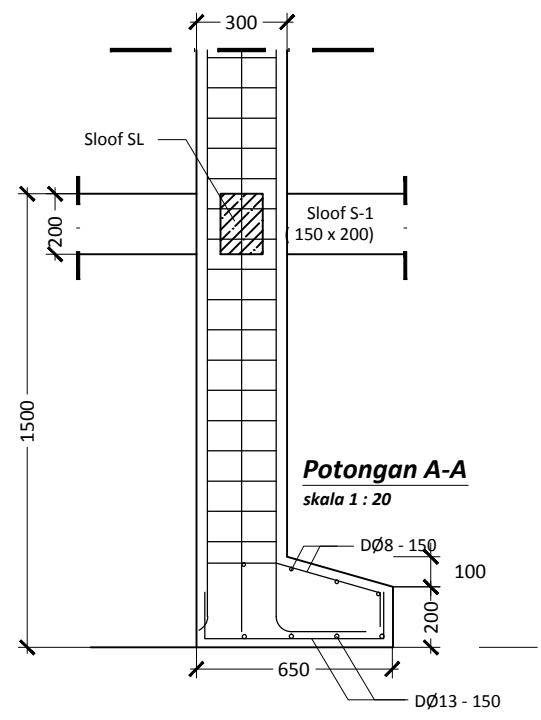
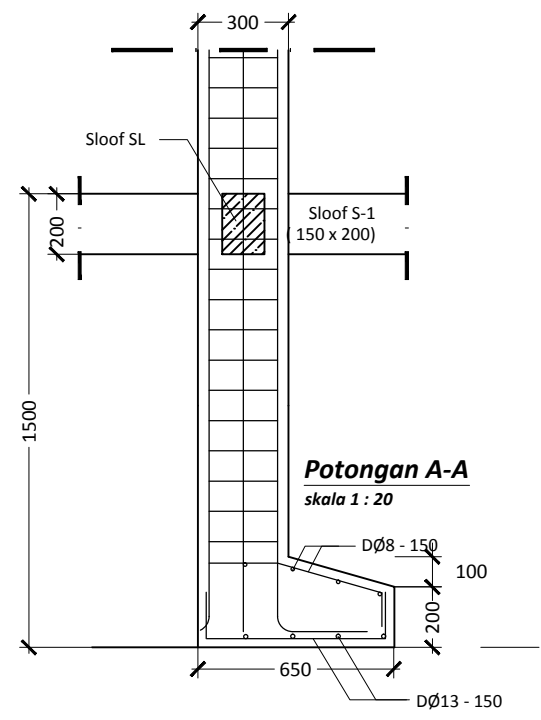
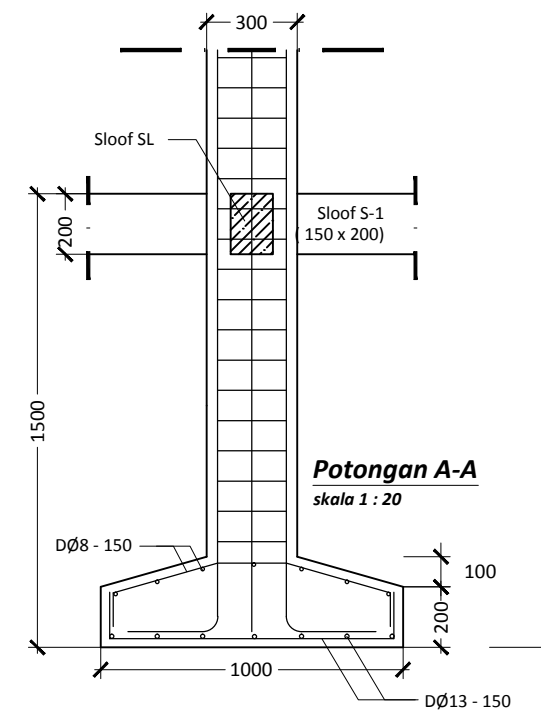

PROJECT NAME	ARCHITECT	OWNER	TITLE	SCALE	NOTE	PAPER
RUMAH 2 LANTAI	 www.argajogja.co.nr	Mr. Supta	DETAIL PONDASI	1:25	asumsi tanah keras kedalaman 1,5 m	A3

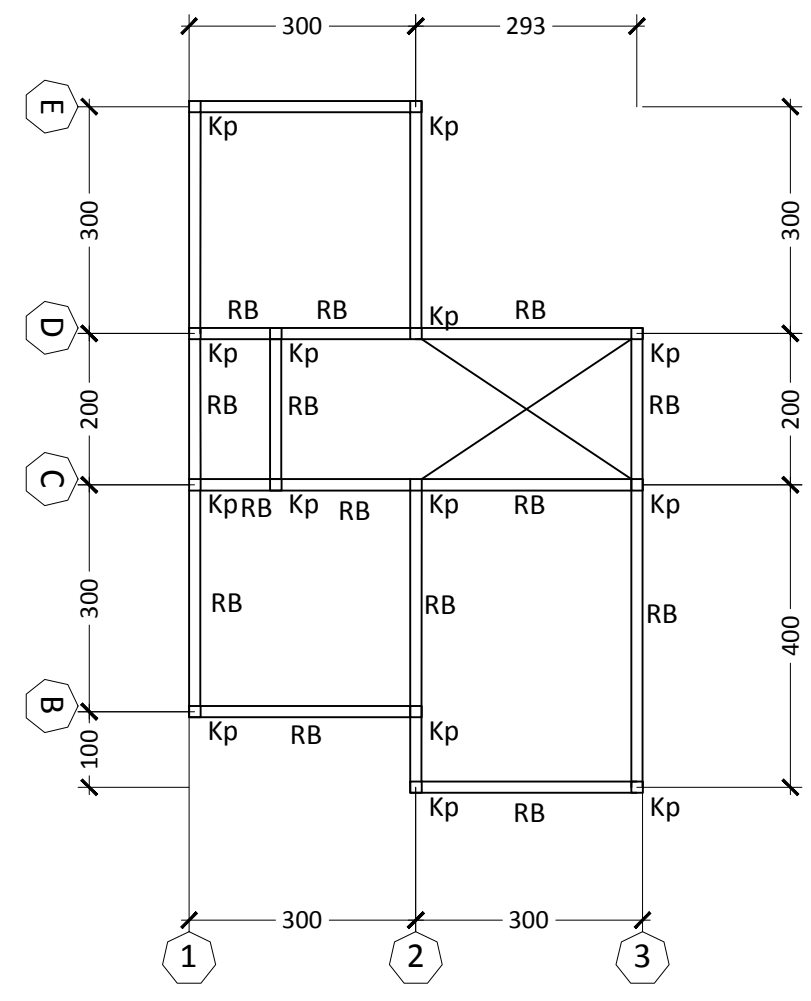
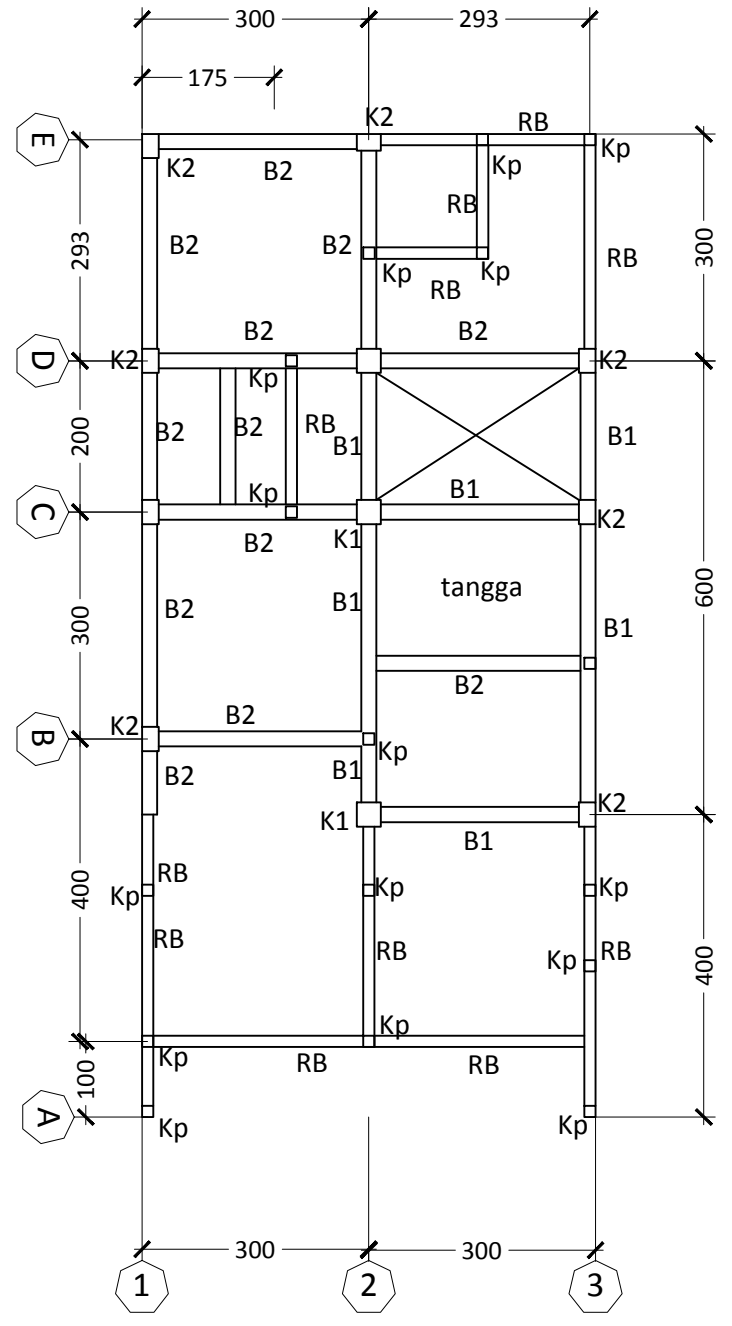



PROJECT NAME	ARCHITECT	OWNER	TITLE	SCALE	NOTE	PAPER
RUMAH 2 LANTAI	 www.argajogja.co.nr	Mr. Supta	RENCANA KOLOM BALOK STRUKTUR	1:100		A3

NOTASI	K-1	K-2	K-3	Kp
GAMBAR				
DIMENSI	300 X 300	200 X 300	200 X 400	150 X 150
TULANGAN	8D13	6D13	10D13	4Ø10
SENGKANG	2PØ10 - 100/200	2PØ10 - 100/200	2PØ10 - 100/200	2PØ10 - 100/200

NOTASI	SL	B1		B2		RB
		TUMPUAN	LAPANGAN	TUMPUAN	LAPANGAN	
GAMBAR						
DIMENSI	200 X 300	200 X 400	200 X 400	200 X 300	200 X 300	150 X 200
TULANGAN ATAS	3D13	5D13	3 D 13	5D13	3 D 13	12P Ø 10
TULANGAN TENGAH	2Ø8	2Ø8	2Ø8	2Ø8	2Ø8	
TULANGAN BAWAH	3 D 13	3 D 13	5D13	3 D 13	5D13	2P Ø 10
SENGKANG	2PØ10 - 100	2PØ10 - 100	2PØ10 - 200	2PØ10 - 100	2PØ10 - 200	2PØ10 - 150

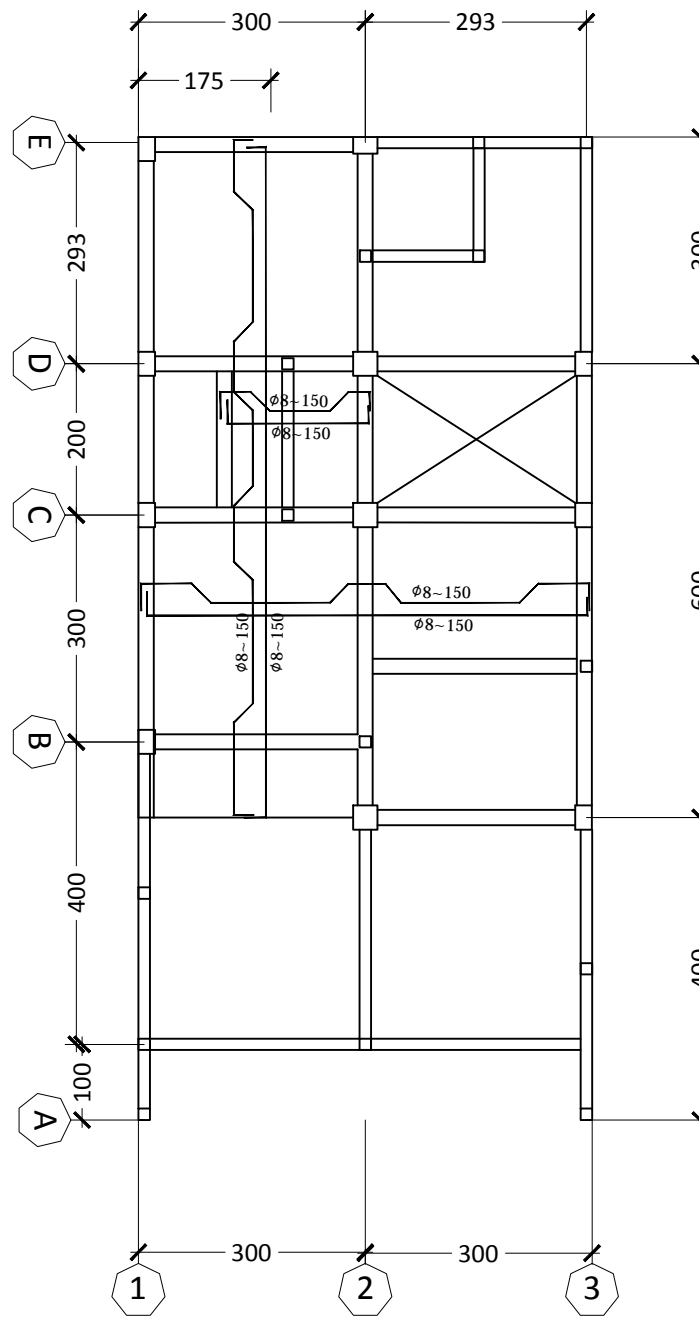
PROJECT NAME	ARCHITECT	OWNER	TITLE	SCALE	NOTE	PAPER
RUMAH 2 LANTAI	www.argajogja.co.nr	Mr. Supta	DETAIL PENULANGAN KOLOM BALOK SLOOF	1:25		A3



PROJECT NAME	ARCHITECT	OWNER	TITLE	SCALE	NOTE	PAPER
RUMAH 2 LANTAI	 www.argajogja.co.nr	Mr. Supta	RENCANA PELAT	1:100		A3

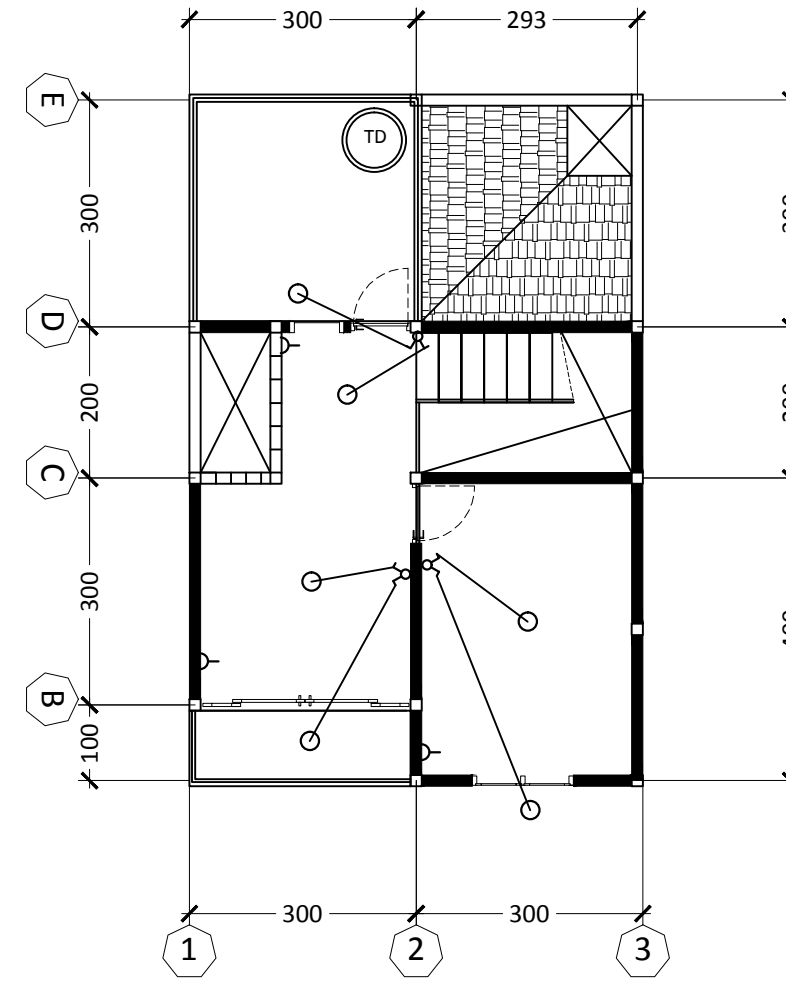
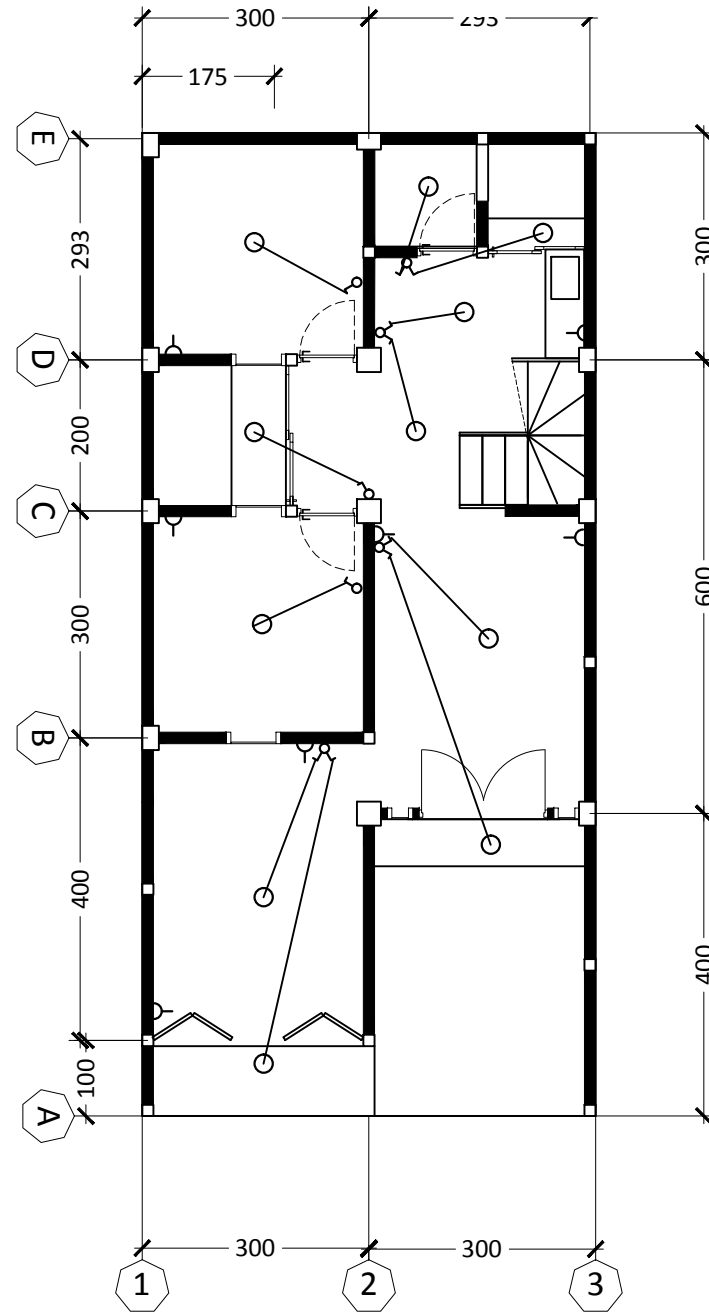

SIMBOL	KETERANGAN
○	= SL Philips 23 watt
⚡	= SAKLAR ganda/ SERI 1.5 mtr dari lantai
⚡	= SAKLAR tunggal 1.5 mtr dari lantai
⌋	= OUTLET STOP KONTAK 0.3 mtr dari lantai

PROJECT NAME	ARCHITECT	OWNER	TITLE	SCALE	NOTE	PAPER
RUMAH 2 LANTAI	 www.argajogja.co.nr	Mr. Supta	RENCANA ELEKTRIKAL	1:100		A3

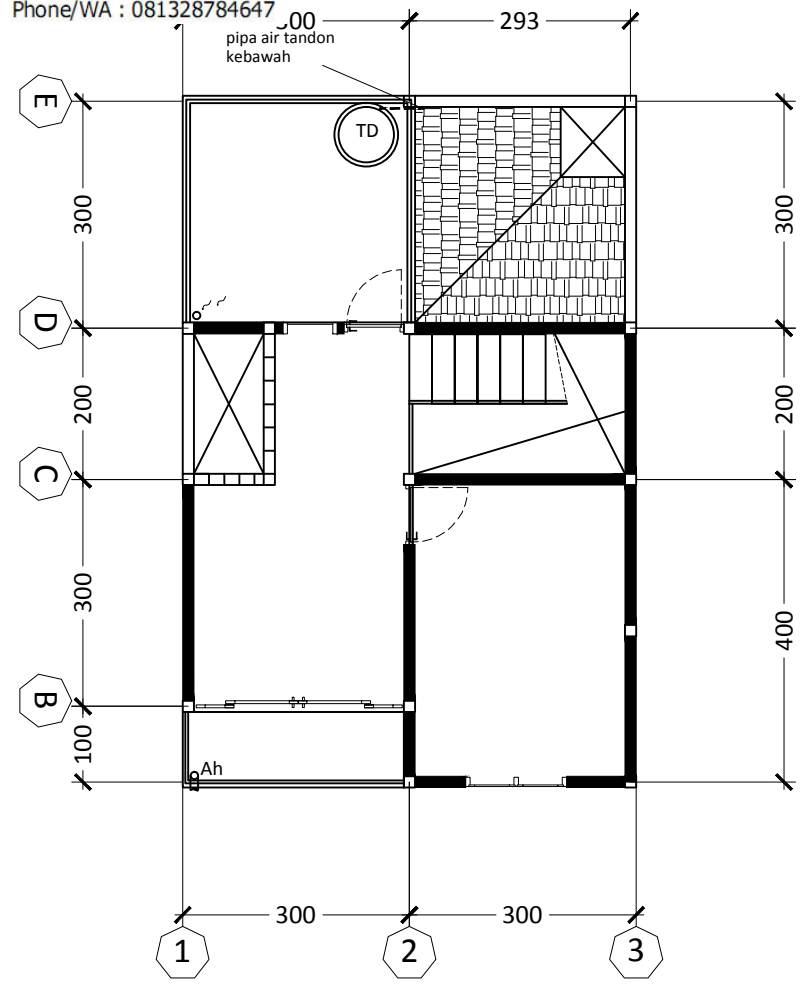
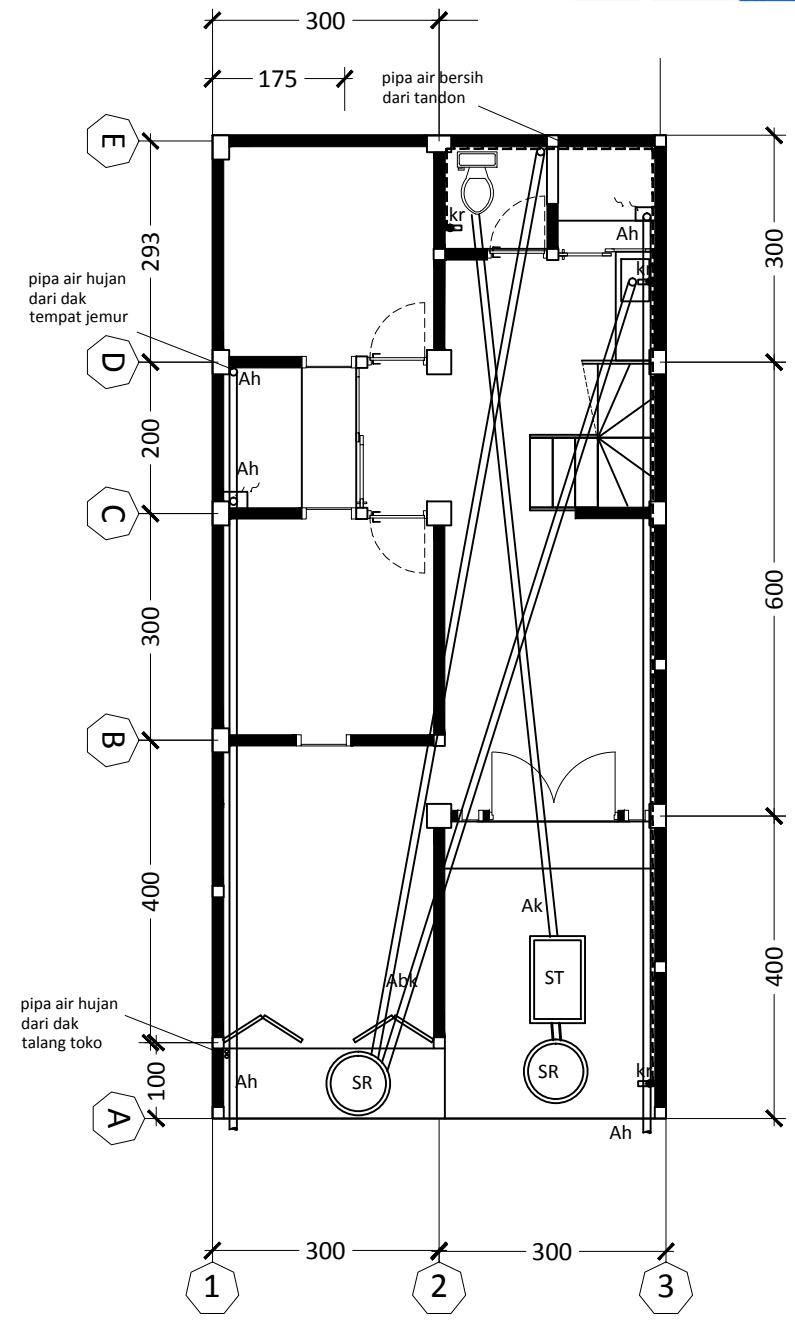

SIMBOL	KETERANGAN
	= SUMUR RESAPAN
	= SEPTIC TANK
	= TANDON
Ak	= Pipa Air kotor
Abk	= Pipa Air bekas
Ab	= Pipa Air bersih
Ah	= Pipa Air Hujan
kr	= kran

PROJECT NAME	ARCHITECT	OWNER	TITLE	SCALE	NOTE	PAPER
RUMAH 2 LANTAI	www.argajogja.co.nr	Mr. Supta	RENCANA SANITASI	1:100		A3

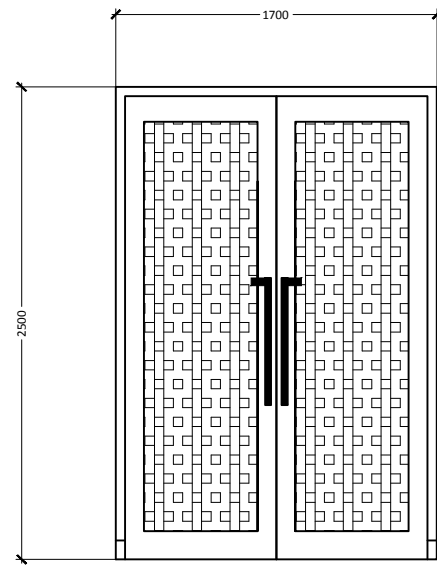

RENCANA P1

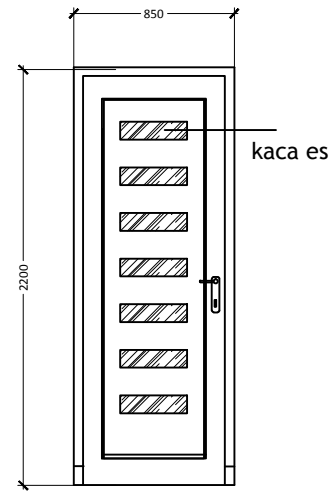

RENCANA P2

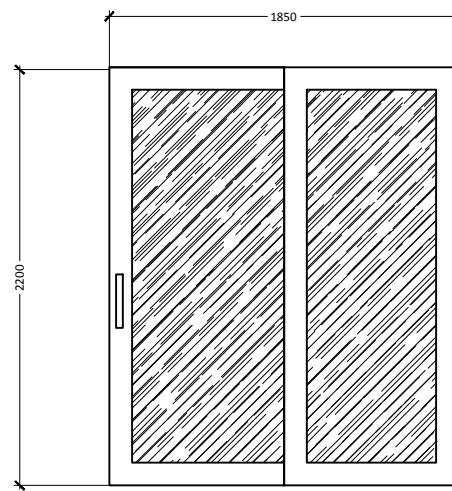

RENCANA PJ1 SLIDING

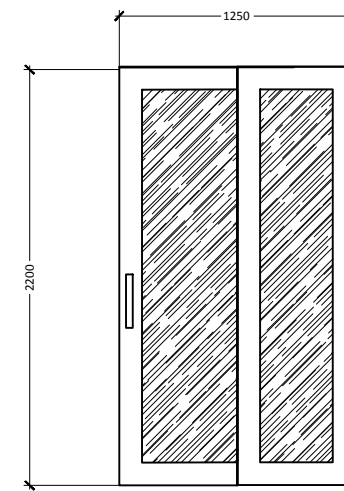

RENCANA PJ2 SLIDING

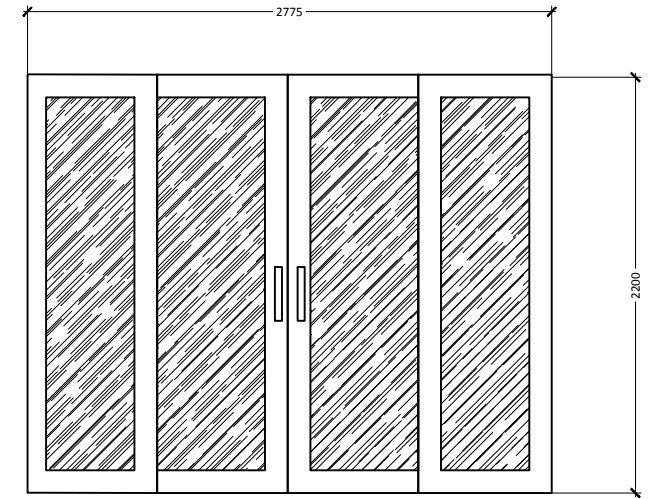

RENCANA PJ3 SLIDING

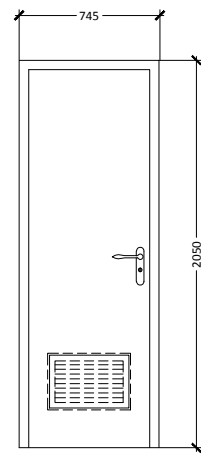

RENCANA P3

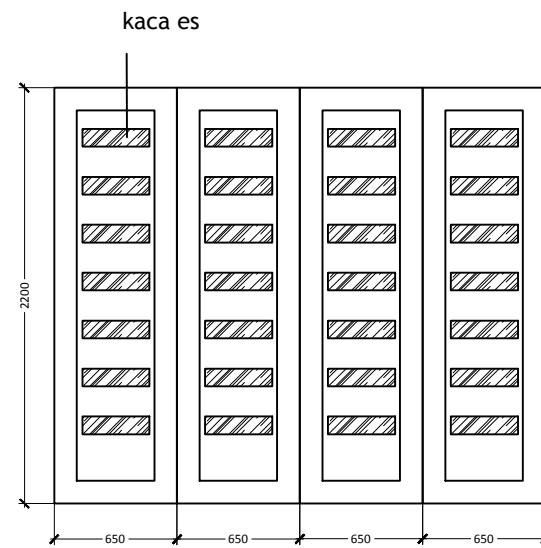

PINTU GARASI LIPAT, P4

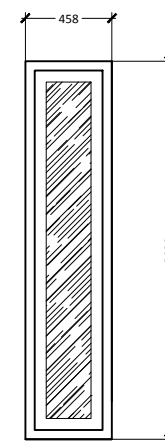

RENCANA J1

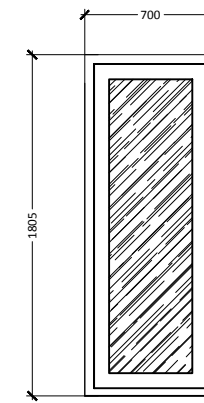

RENCANA J2

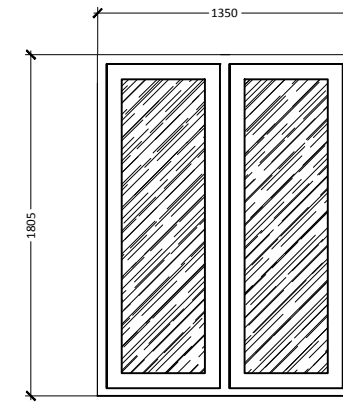

RENCANA J3

PROJECT NAME	ARCHITECT	OWNER	TITLE	SCALE	NOTE	PAPER
RUMAH 2 LANTAI	 www.argajogja.co.nr	Mr. Supta	RENCANA PINTU JENDELA	1:40		A3