

GAMBAR KERJA RUMAH TINGGAL

Milik :
Bp. Triawan Nugroho

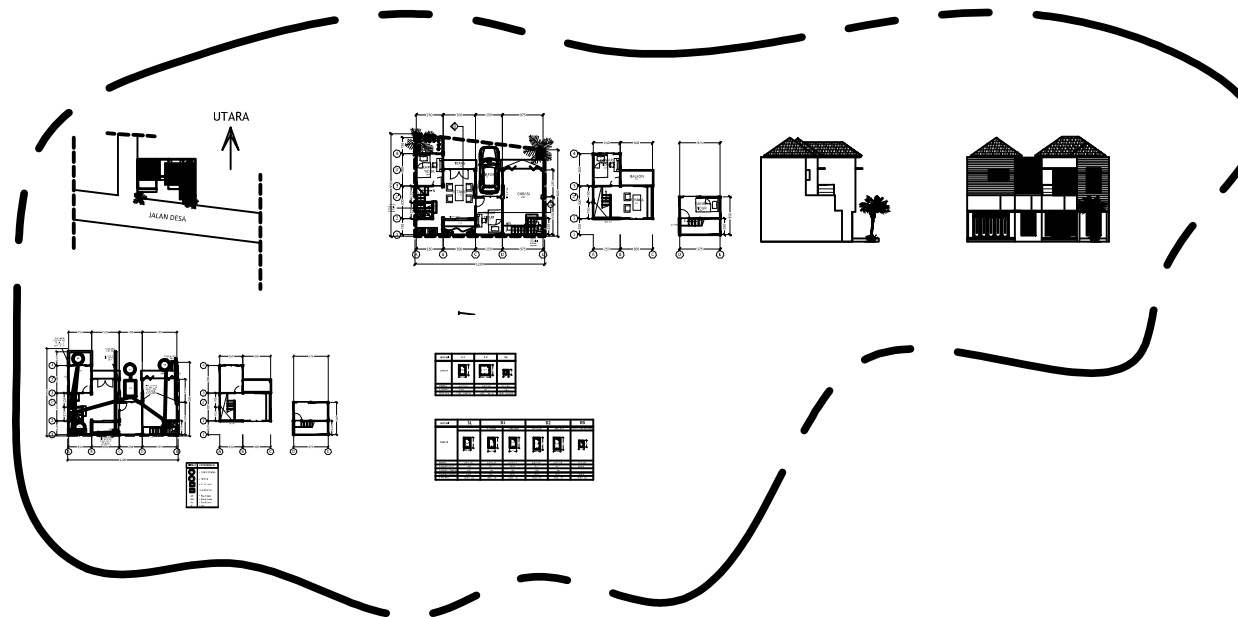

design by



ARGAJOGJA
Architecture, Interior, Engineering

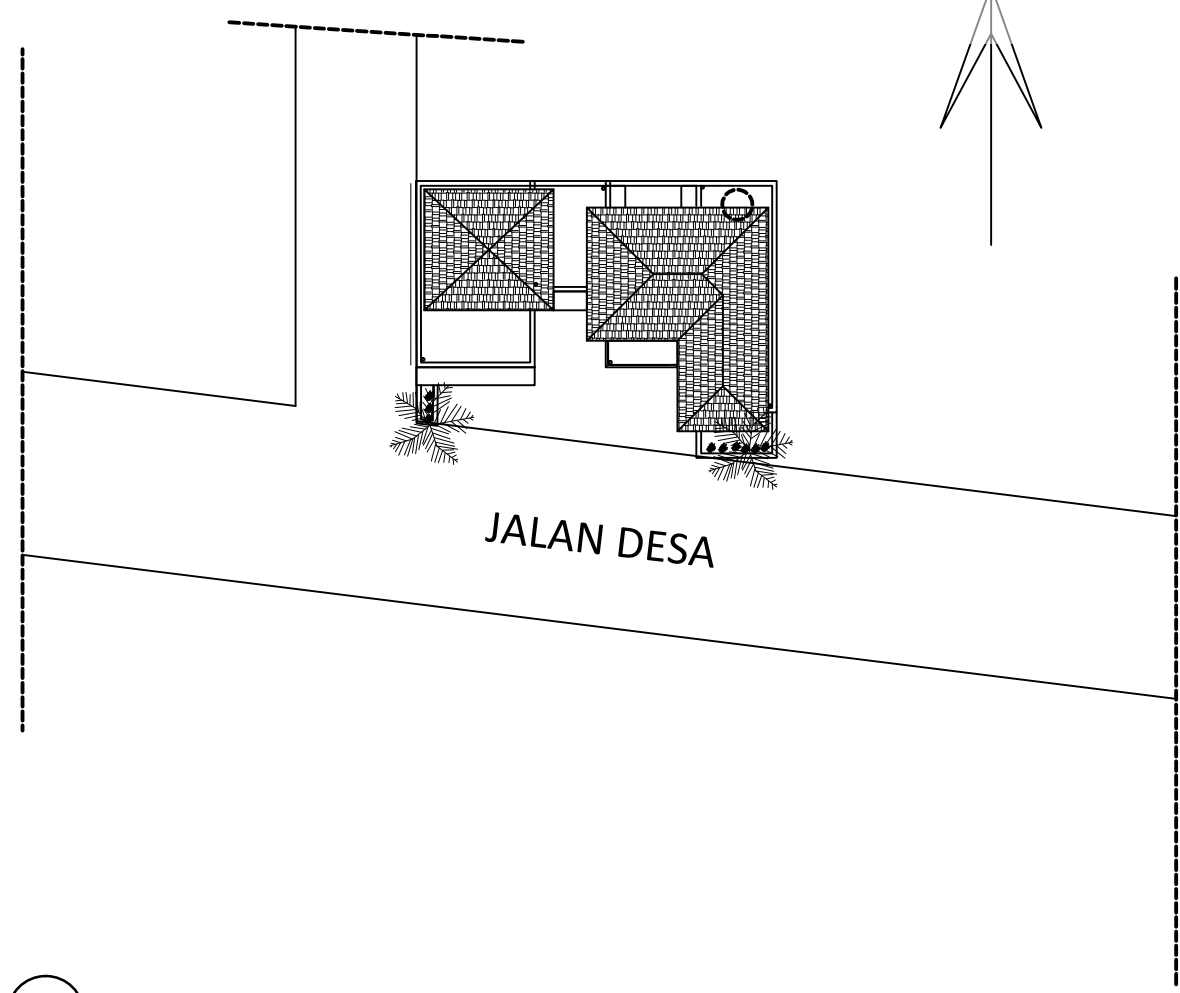
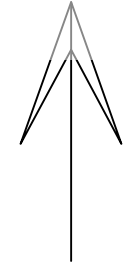

SITEPLAN
 SKALA 1:1250

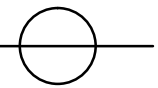

PROJECT NAME	ARCHITECT	OWNER	TITLE	SCALE	PAPER	NOTE
RUMAH TINGGAL	 ARGAJOGJA <small>Architecture Interior Engineering</small>	TRIAWAN NUGROHO	SITEPLAN	1:1250	A4	

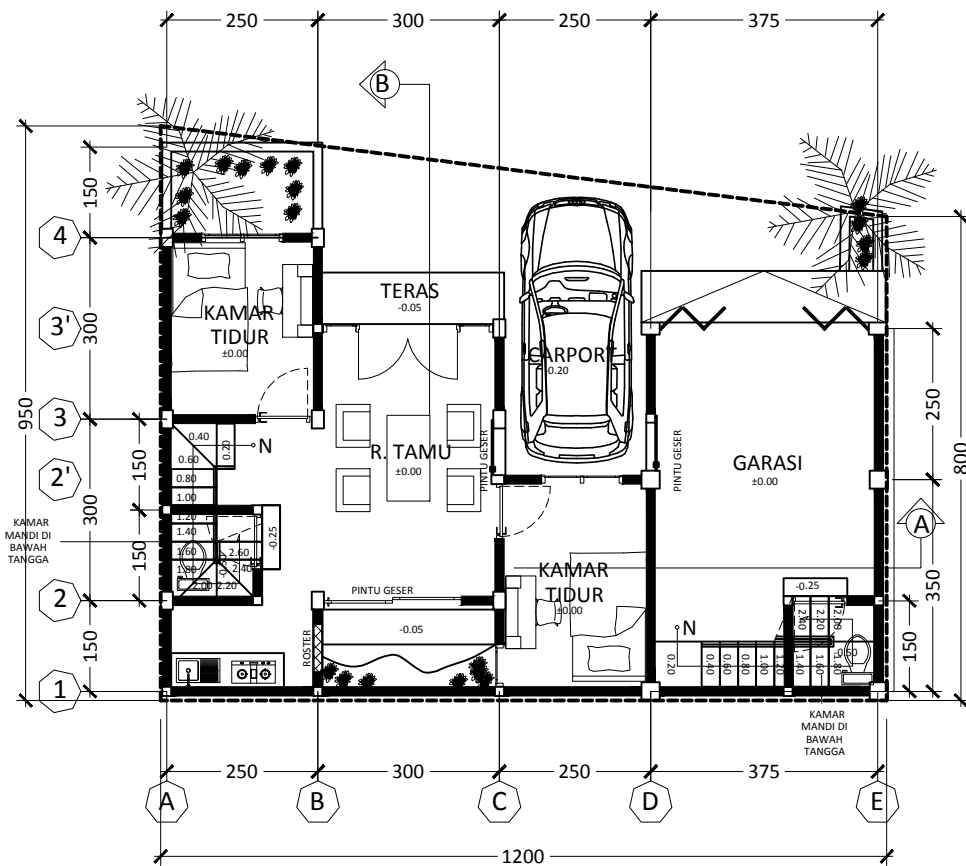

DENAH LANTAI 1
SKALA 1:125

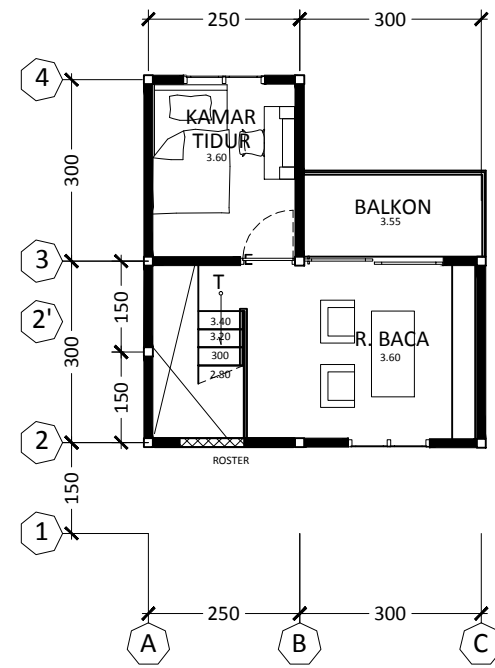

DENAH LANTAI 2
SKALA 1:125

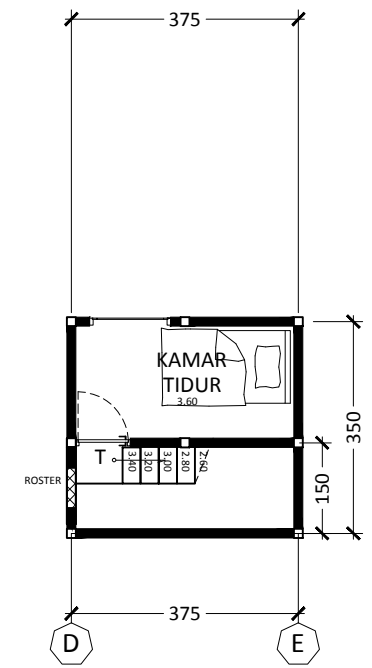

PROJECT NAME	ARCHITECT	OWNER	TITLE	SCALE	PAPER	NOTE
RUMAH TINGGAL	 ARGAJOGJA <small>architectural interior engineering</small>	TRIAWAN NUGROHO	DENAH	1:125	A4	



T. DEPAN
SKALA 1:125

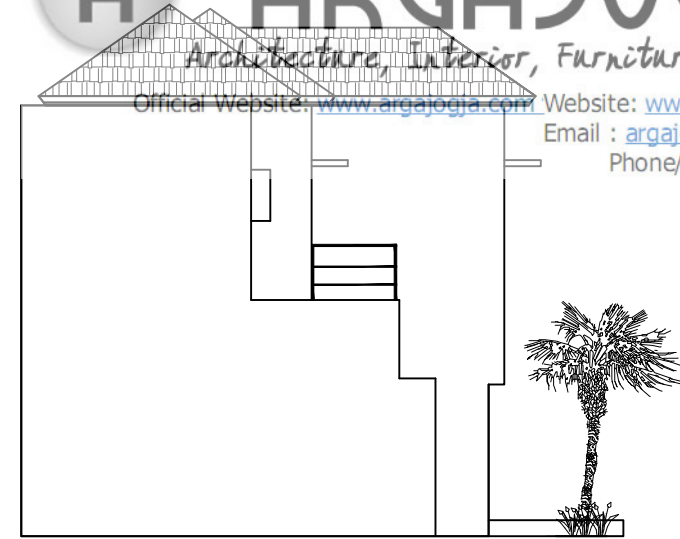

T. KANAN
SKALA 1:125



T. BELAKANG
SKALA 1:125

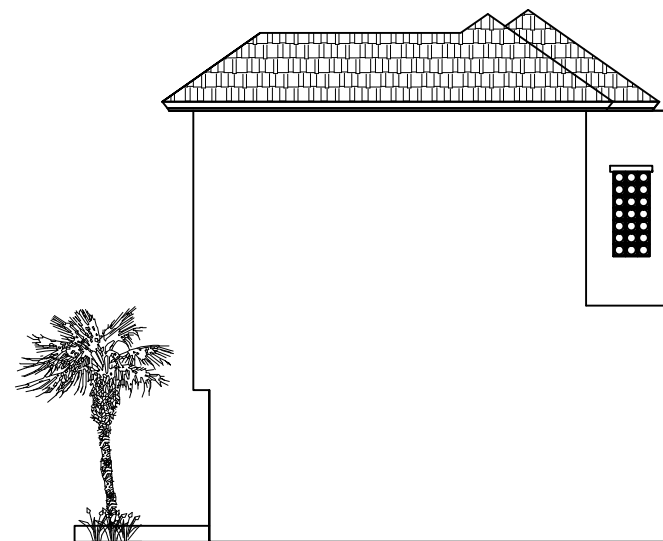

T. KIRI
SKALA 1:125

PROJECT NAME	ARCHITECT	OWNER	TITLE	SCALE	PAPER	NOTE
RUMAH TINGGAL	 ARGAJOGJA <small>Architecture Interior Engineering</small>	TRIAWAN NUGROHO	TAMPAK	1:125	A4	

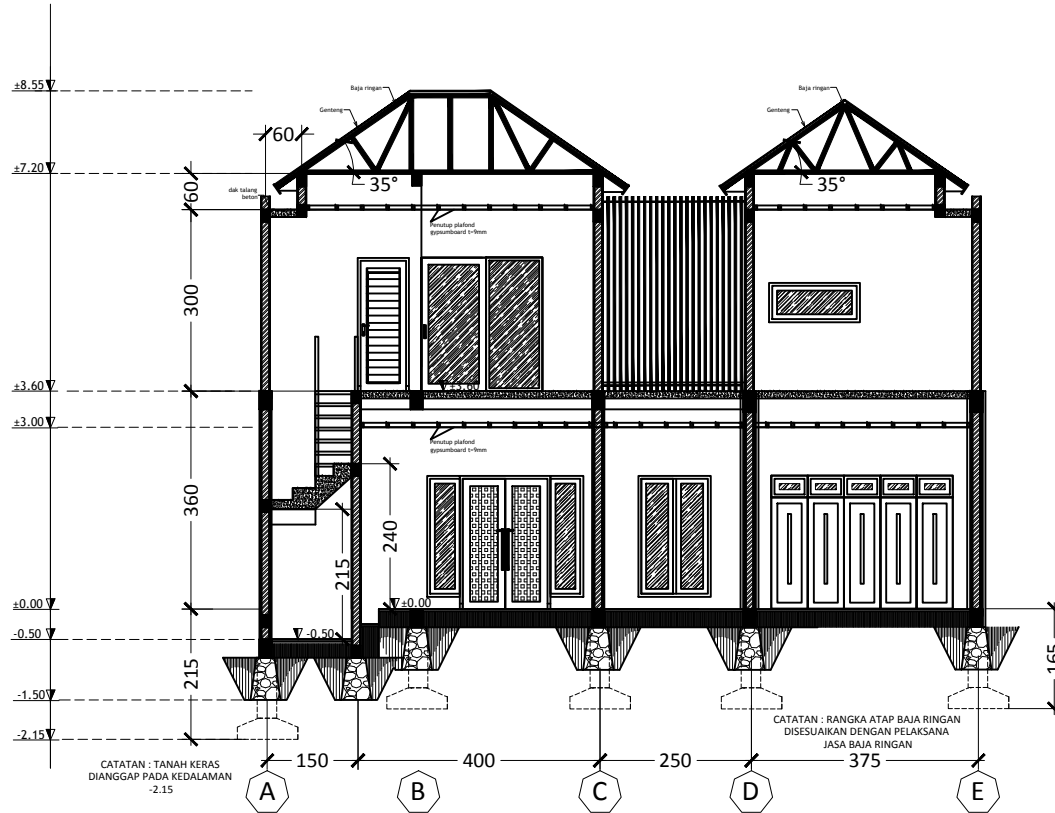

POTONGAN A
SKALA 1:125

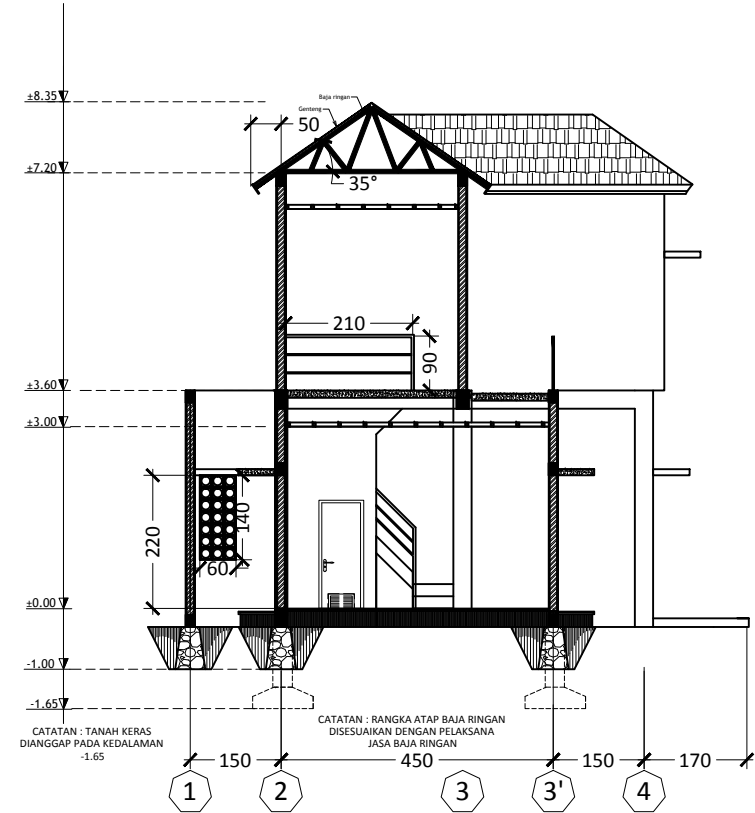

POTONGAN B
SKALA 1:125

PROJECT NAME	ARCHITECT	OWNER	TITLE	SCALE	PAPER	NOTE
RUMAH TINGGAL	 ARGAJOGJA <i>Architecture Interior Engineering</i>	TRIAWAN NUGROHO	POTONGAN	1:125	A4	

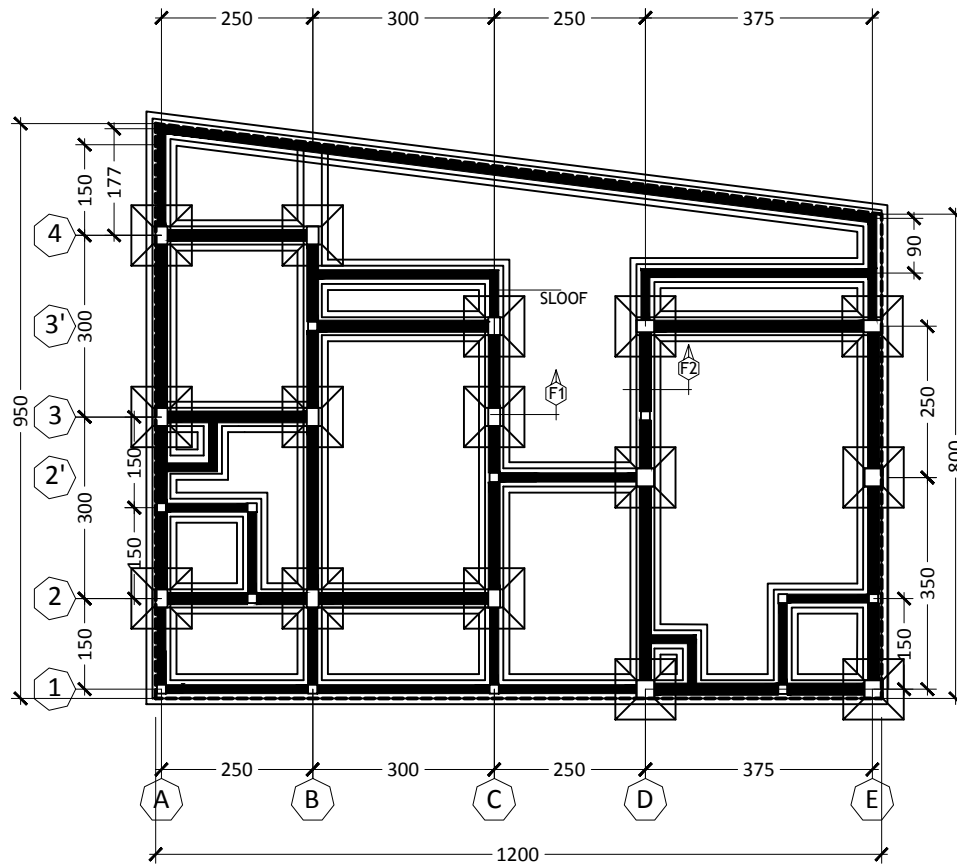

DENAH PONDASI
SKALA 1:125

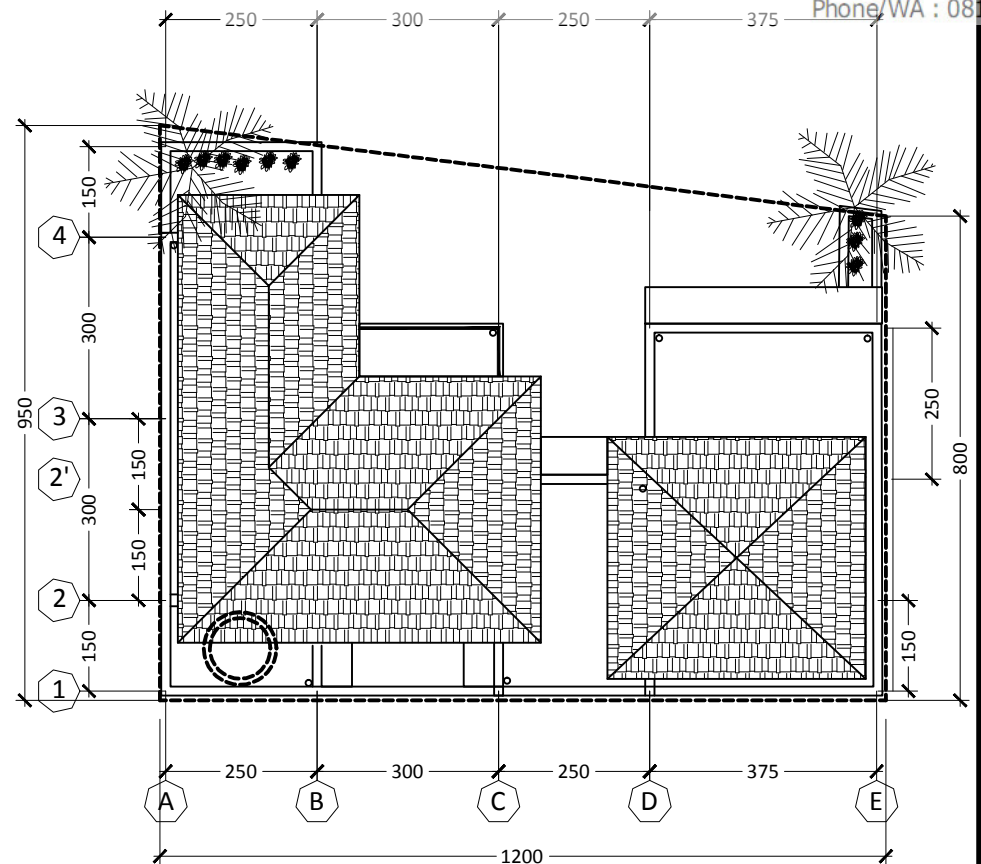

RENCANA ATAP
SKALA 1:125



PROJECT NAME	ARCHITECT	OWNER	TITLE	SCALE	PAPER	NOTE
RUMAH TINGGAL	 ARGAJOGJA Architectural Interior Engineering	TRIAWAN NUGROHO	PONDASI & ATAP	1:125	A4	

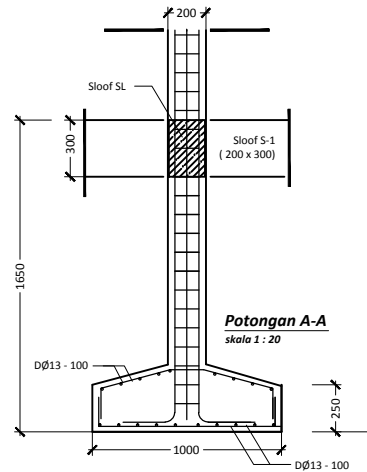
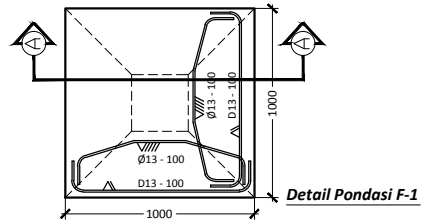

ASUMSI TANAH KERAS PADA KEDALAMAN 1,65 M

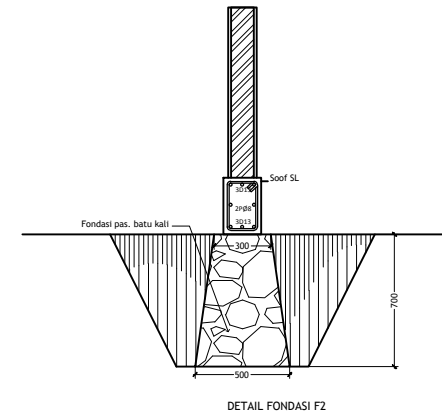

DETAIL PONDASI
SKALA 1:40

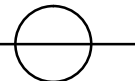

PROJECT NAME	ARCHITECT	OWNER	TITLE	SCALE	PAPER	NOTE
RUMAH TINGGAL	 ARGAJOGJA Architecture Interior Engineering	TRIAWAN NUGROHO	DETAIL PONDASI	1:40	A4	

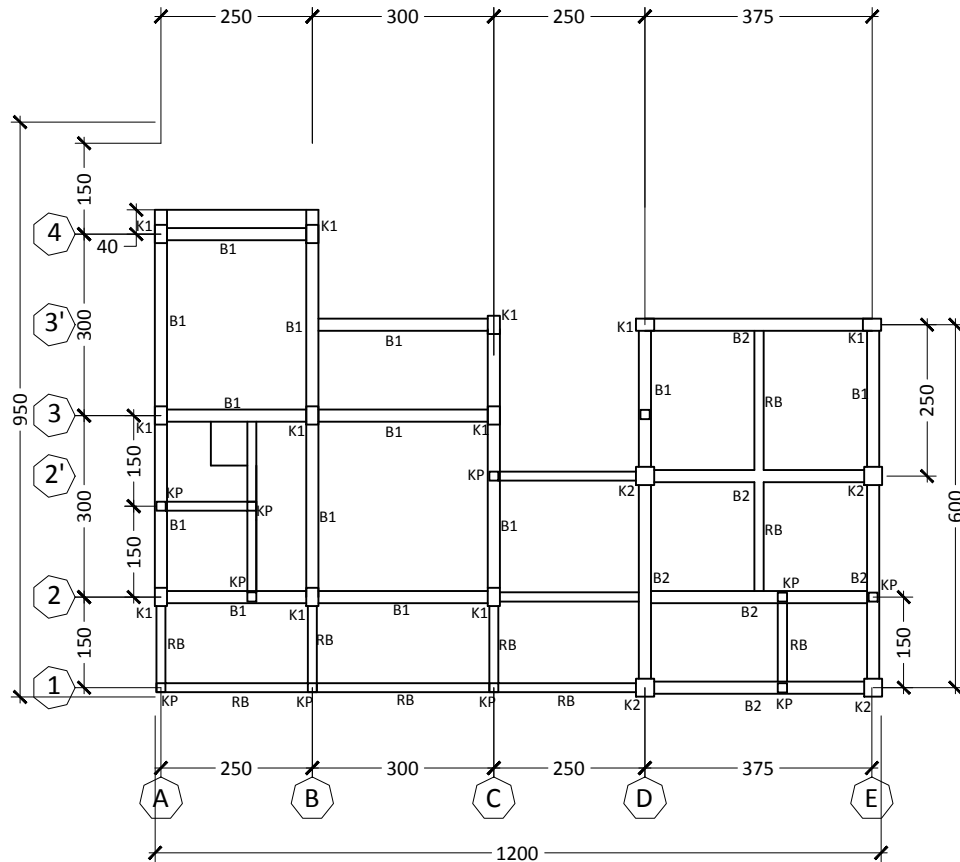

KOLOM BALOK LT. 1
SKALA 1: 125

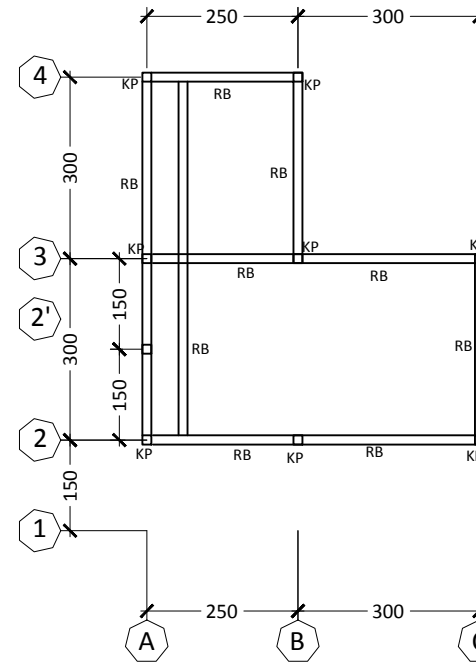
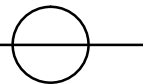

KOLOM BALOK LT. 2
SKALA 1: 125

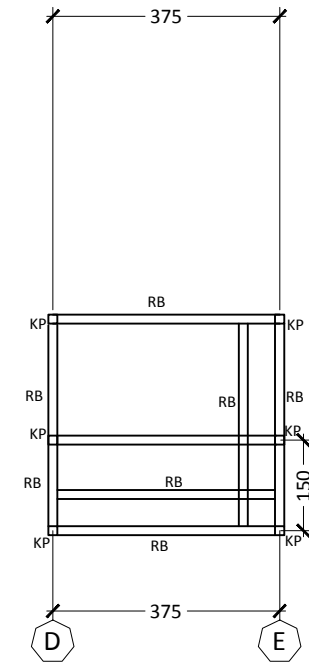
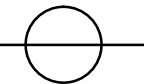

PROJECT NAME	ARCHITECT	OWNER	TITLE	SCALE	PAPER	NOTE
RUMAH TINGGAL	 ARGAJOGJA <small>architect interior engineering</small>	TRIAWAN NUGROHO	KOLOM BALOK	1:25	A4	

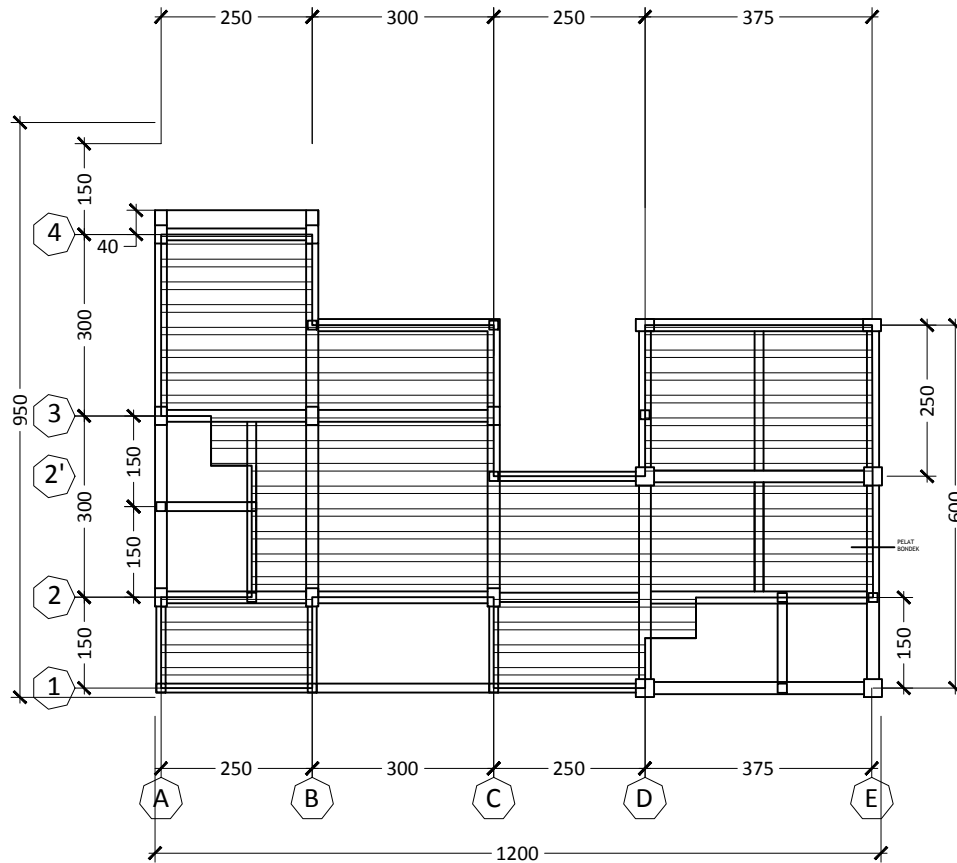

PELAT BONDEK LANTAI 1
SKALA 1:125

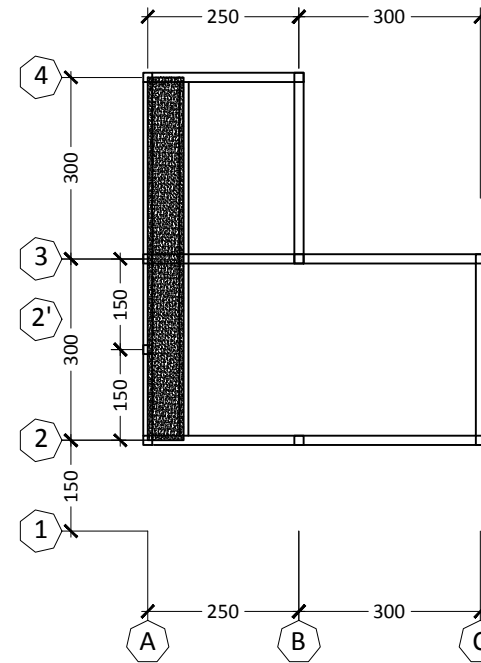

TALANG BETON LANTAI 2
SKALA 1:125

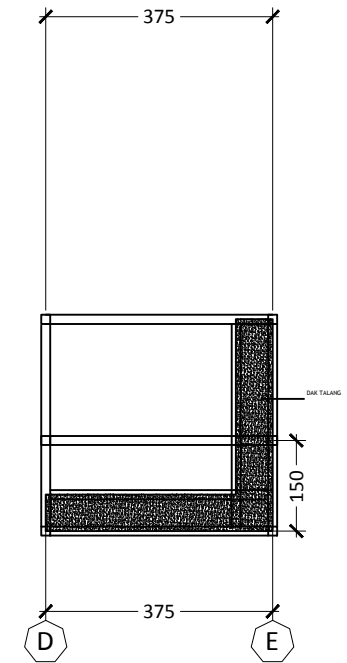

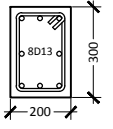
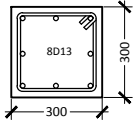
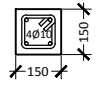

PROJECT NAME	ARCHITECT	OWNER	TITLE	SCALE	PAPER	NOTE
RUMAH TINGGAL	 ARGAJOGJA Architectural Interior Engineering	TRIAWAN NUGROHO	PELAT	1:125	A4	

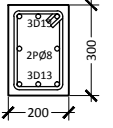
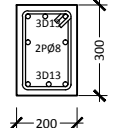
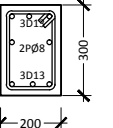
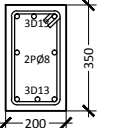
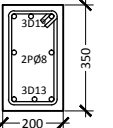
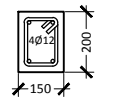
NOTASI	K-1	K-2	Kp
GAMBAR			
DIMENSI	200 X 300	300 X 300	150 X 150
TULANGAN	8D13	8D13	4Ø12
SENGKANG	2PØ8 - 100/150	2PØ8 - 100/150	2PØ8 - 100/150

NOTASI	SL	B1		B2		RB
		TUMPUAN	LAPANGAN	TUMPUAN	LAPANGAN	
GAMBAR						
DIMENSI	200 X 300	200 X 300	200 X 300	200 X 350	200 X 350	150 X 200
TULANGAN ATAS	3D13	3D13	3D13	3D13	3D13	2P Ø 10
TULANGAN TENGAH	2Ø8	2Ø8	2Ø8	2Ø8	2Ø8	
TULANGAN BAWAH	3D13	3D13	3D13	3D13	3D13	2P Ø 10
SENGKANG	2PØ8 - 150	2PØ8 - 100	2PØ8 - 150	2PØ8 - 100	2PØ8 - 150	2PØ8 - 150

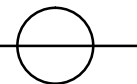
DETAIL PENULANGAN
SKALA 1: 25



PROJECT NAME	ARCHITECT	OWNER	TITLE	SCALE	PAPER	NOTE
RUMAH TINGGAL	 ARGAJOGJA <small>architectareinteriorengineering</small>	TRIAWAN NUGROHO	PENULANGAN	1:25	A4	

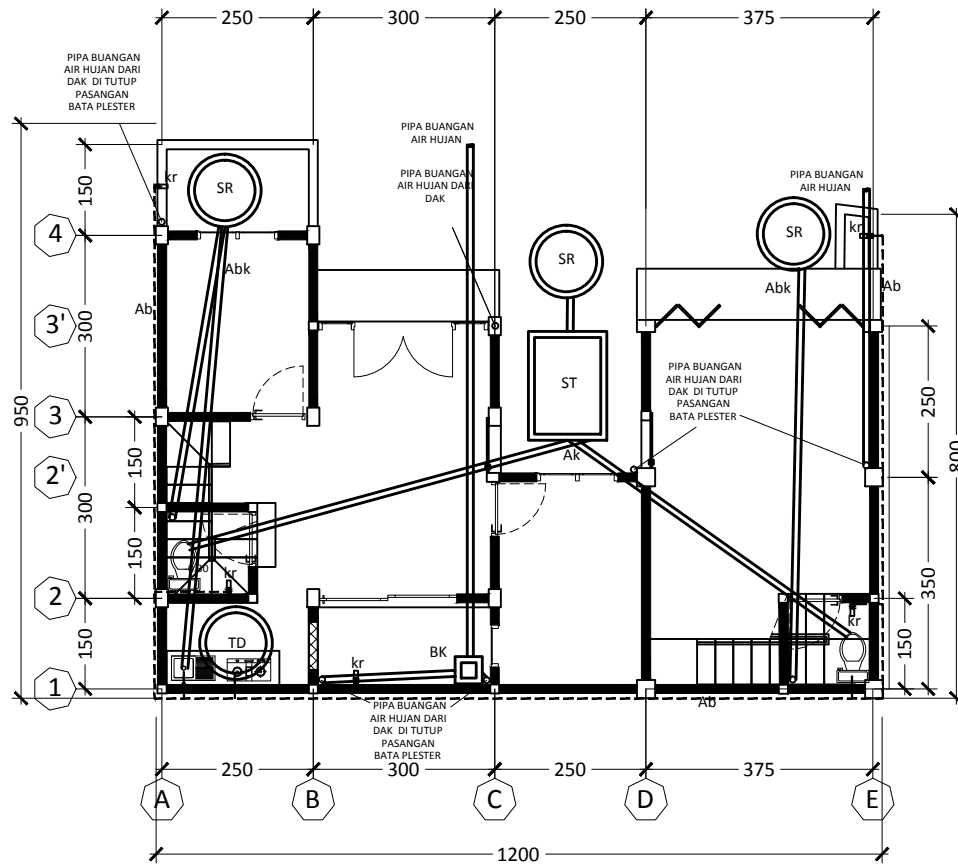

SANITASI LANTAI 1
SKALA 1:125

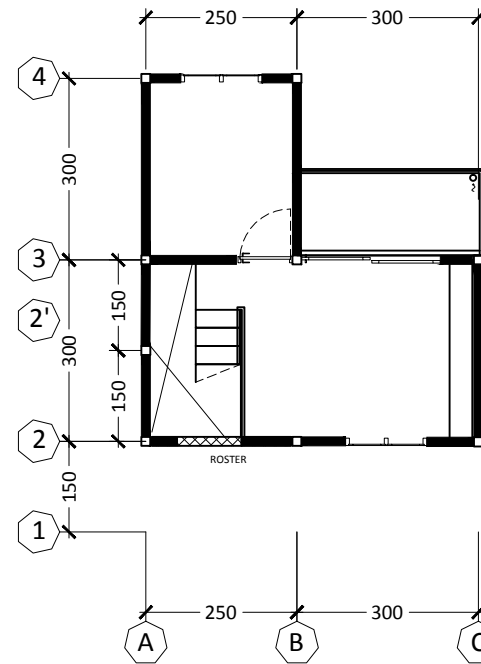
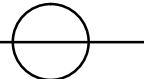

SANITASI LANTAI 2
SKALA 1:125

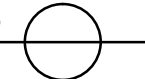

SIMBOL	KETERANGAN
	= SUMUR RESAPAN
	= TANDON
	= SEPTIC TANK
	= BAK KONTROL
Ak	= Pipa Air kotor
Abk	= Pipa Air bekas
Ab	= Pipa Air bersih
kr	= kran

PROJECT NAME	ARCHITECT	OWNER	TITLE	SCALE	PAPER	NOTE
RUMAH TINGGAL	ARGAJOGJA <small>Architecture Interior Engineering</small>	TRIAWAN NUGROHO	SANITASI	1:125	A4	

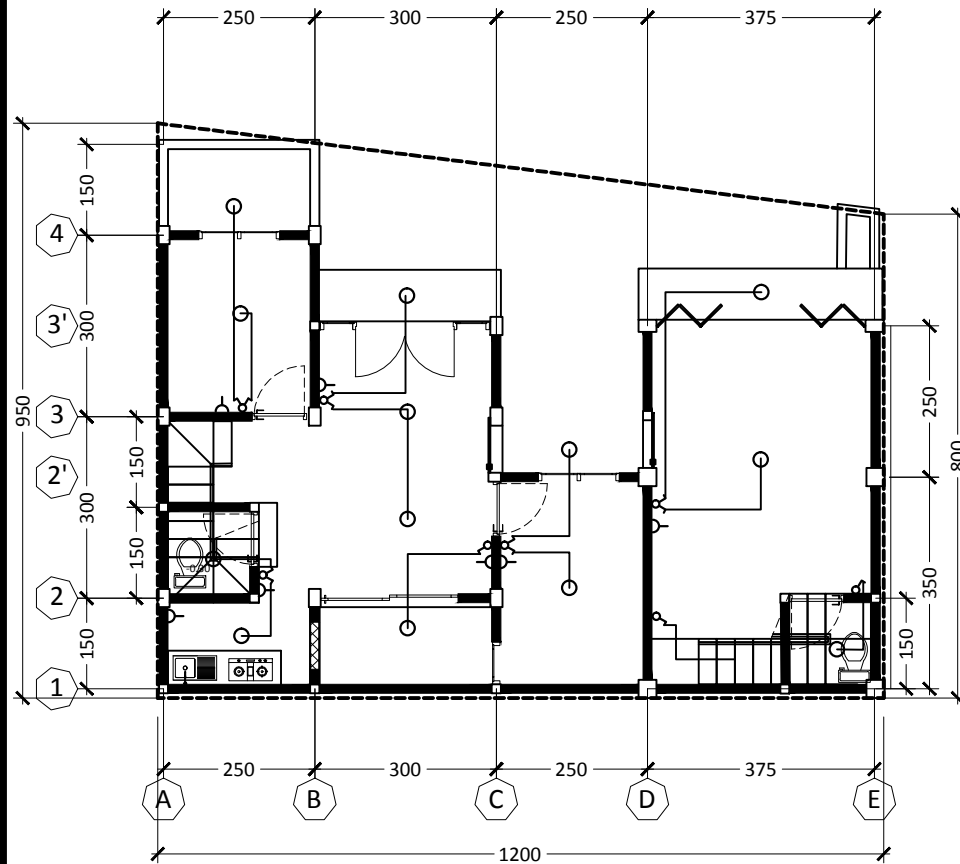

ELEKTRIKAL LANTAI 1
SKALA 1:125

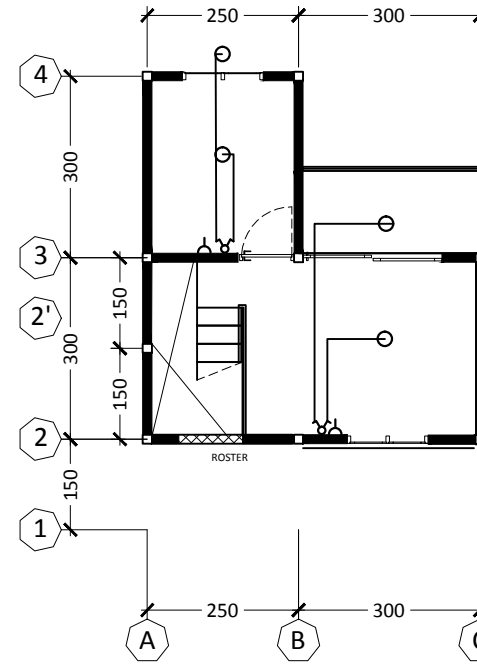
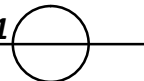

ELEKTRIKALI LANTAI 2
SKALA 1:125

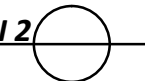

SIMBOL	KETERANGAN
○	= TITIK lampu
⚡	= SAKLAR ganda/ SERI 1.5 mtr dari lantai
♂	= SAKLAR tunggal 1.5 mtr dari lantai
⌋	= OUTLET STOP KONTAK 0.3 mtr dari lantai

PROJECT NAME	ARCHITECT	OWNER	TITLE	SCALE	PAPER	NOTE
RUMAH TINGGAL	 ARGAJOGJA <i>architect&interior engineering</i>	TRIAWAN NUGROHO	ELEKTRIKAL	1:125	A4	

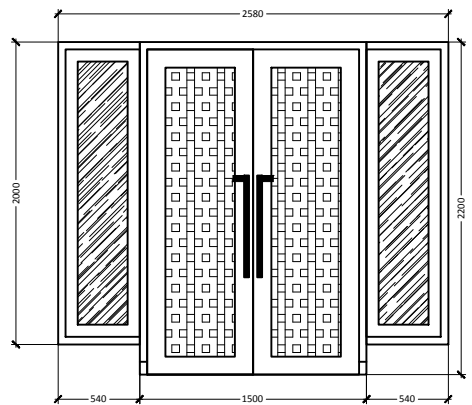

PINTU RUANG TAMU

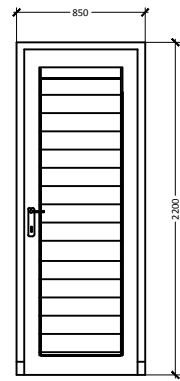

PINTU GESER BALKON

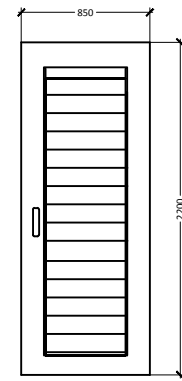

PINTU GESER SAMPING



PINTU GESER BELAKANG/BALKON

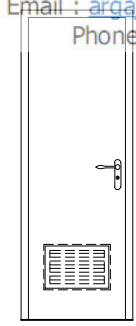

PINTU FIBER KM
UKURAN SESUAI
STANDAR PABRIK

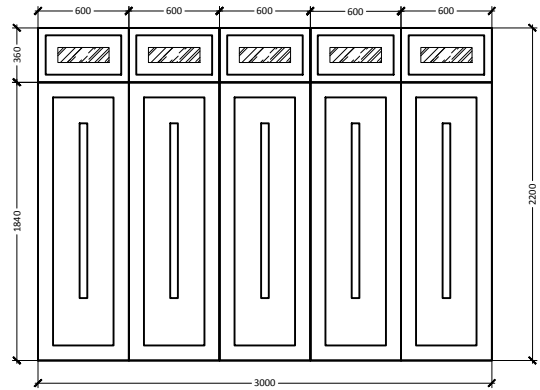

PINTU TOKO

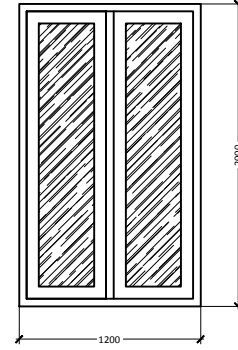

JENDELA KAMAR

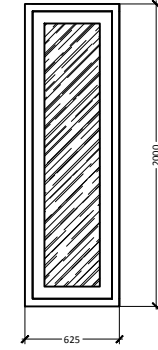

JENDELA KAMAR BELAKANG

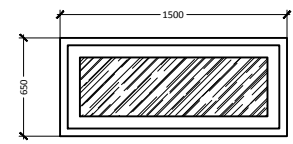

JENDELA KAMAR TOKO

PINTU JENDELA
SKALA 1: 50

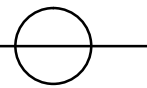

PROJECT NAME	ARCHITECT	OWNER	TITLE	SCALE	PAPER	NOTE
RUMAH TINGGAL	 ARGAJOGJA <small>Architect Interior Engineering</small>	TRIAWAN NUGROHO	PINTU JENDELA	1:50	A4	